

VIGILEX®

SAFETY PROTECTION By **STIF**

EXPLOSION PROTECTION



STIF

components for your success

English



THE SIX REQUIREMENTS FOR A DUST EXPLOSION

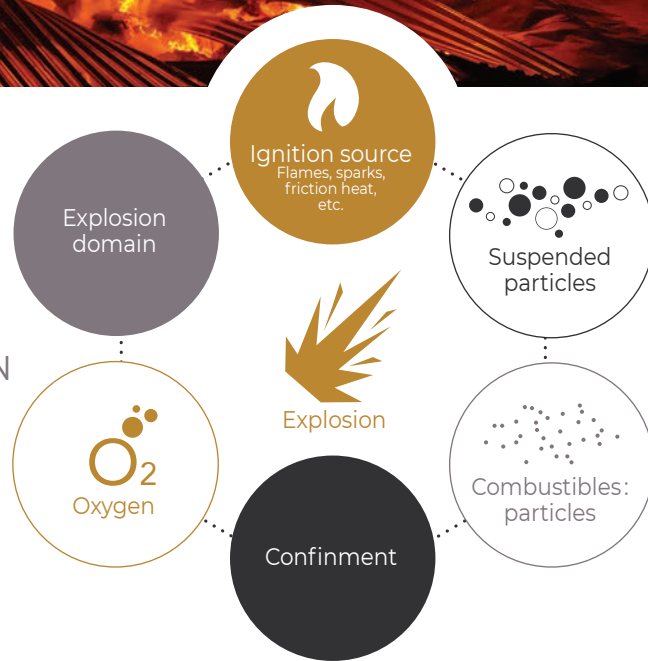

Explosion venting is one of the most common and effective forms of explosion protection. Relieving the overpressure from a potential industrial explosion and providing a planned pathway for the expanding gases to escape.

WHAT IS A DUST EXPLOSION ?

- It begins with the ignition of a fuel which burns instantaneously
- An explosion produces and release a large cloud of gas or dust
- An explosion does not require a flame
- A vessel can bursts from increased internal pressure, and then it 's called an explosion

WHAT IS AN EXPLOSION VENTING ?

- A designed weak point in a pressure system
- Limit the explosion overpressure by releasing unburned mixture and products of combustion
- Panels do not prevent an explosion they prevent the vessel from over pressure by allowing us to control the maximum pressure
- A non-reclosing pressure relief device to discharge outside the explosion energy
- designed to fail at a pre-determined pressure

VIGILEX explosion protection devices are designed by the **STIF** company, who are specialists in the manufacture of components for the bulk handling industry.

Established in 1984 the **S.T.I.F.** Company has earned a solid international reputation by exporting to more than 70 countries.

The 10 000 m² production facility and global headquarters is based in the west of France near ANGERS, 80 km from the port of NANTES-ST NAZAIRE.

Following the successful launch of the explosion vent panels several years ago the company introduced the **VIGILEX VQ Flameless Venting**. This new explosion protection device is designed to protect personnel and equipment from the effect of an explosion within a plant environment also to replace the costly generally used ductwork solution that conveys the explosion outside the building. The **VIGILEX VQ** is the first Flameless venting in the market to be approved following the new standard **EN16009** (Flameless explosion venting devices).

With technical expertise in dust explosion STIF provides a comprehensive service to offer help and advice on your particular project.

Our website www.vigilex.eu is an open source platform which allows you to download drawings of each panel, a questionnaire form is also available with all of the information required to define the vent area to protect your equipment (Filters, Dust Collectors, Silos, Elevators).

From our modern in house test facility we offer pressure test certificates along with certificates of conformity following the latest standards.

Our staff pride themselves on offering you, the customer a first class product and service.

CERTIFICATIONS

Ex II GD

EN 14491-2012/ EN 14994-2007/ EN 14797-2007/ EN 1127-1:2019

EN 16009-2011

EU Certificate: INERIS 15ATEX0001X

EU Certificate: INERIS 14ATEX0049X

Production quality assurance notification: INERIS 08ATEXQ406



CERTIFICATIONS, CALCULATION & **TESTS**

The **VIGILEX explosion vent panels** and **flameless venting** are Atex approved products certified by the French notified body INERIS.



STIF is the only French company to have **EU certificate** for this kind of products. STIF is also certified **ISO 9001 AFAQ**.

In the event of an explosion the vent panels are designed to evacuate the pressure in order to protect both the workforce and surrounding facilities. The Vigilex explosion vent panels offer a simple and efficient protection system which is designed to resist vacuum under cycling conditions and can be used in silos, cyclones, filters units and vessels.



CALCULATION

We determine for you the surface areas of the vents to be placed in your installations to be protected. Thanks to the main specific information related to the characteristics of your installations (KST, Predmax, Pmax, your installations size, etc.), which you will indicate to us. We can calculate the safety area adapted to your needs and conforming to the standards **EN14491**, **EN14994**, **VDI3673** and **NFPA 68**.

And, backed by our experienced technical department, we can offer a comprehensive service to guide you in your choices and optimize your investments.

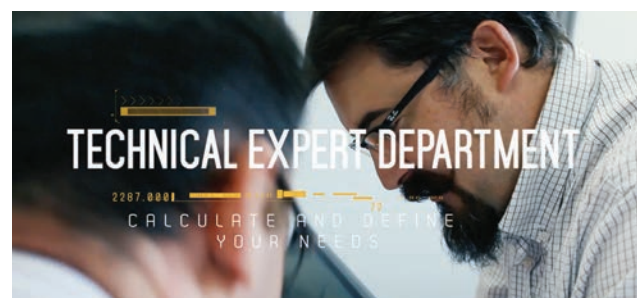

VENT PANEL EXPLOSION TEST

STIF delivers conformity declarations by testing each explosion vent panel in its own test room.



DIRECTIVE: 2014/34/UE



QUALITY CONTROL

We test the vent panels in our factory according to **EN 14 797**. These panels are manufactured under the EU examination certificate type Ineris **15ATEX0001X**, **14ATEX0049X** and the quality management system of the company is certified by the EU quality certification Ineris **08ATEXQ406**.

Our range of products are supplied with a certificate of conformity complete with burst test results along with installation guidelines.

CERTIFICATIONS

EXPLOSION VENT PANEL STANDARD

- Ex II GD
- EN14 491 / EN14 994 / EN14 797 / EN1127.1
- EU Type examination certificate:
INERIS 15ATEX0001X
- Production quality assurance notification:
INERIS 08ATEXQ406

CERTIFICATIONS

FLAMELESS DEVICES STANDARD

- Ex II GD / Ex II 2 D
- EN 16009
- EU type examination certificate:
INERIS 14ATEX0049X
- Production quality assurance notification:
INERIS 08ATEXQ406

CERTIFIED FOR:

- Organic dust
- Fiber dust
- Metal dust
- Gas

SUMMARY

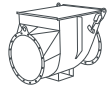

Explosion Isolation Valve

VIGIFLAP

Explosion Isolation Valve

8

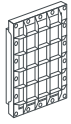

Flameless Devices

VIGIFLAM VI

Flameless venting for elevator

14

VIGIFLAM VQ

Flameless venting

16

VIGIFLAM VQ-R

Curved flameless venting

18

VIGIFLAM VQ-SST

stainless steel Flameless

19



Explosion Vent Panel

VIGILEX VL

Single flat

20

VIGILEX VL-R

Single curved

22

VIGILEX VL-SANITARY

Hygienic applications

24

VIGILEX VD

Single domed

26

VIGILEX VD-HV

Single domed high vacuum resistant

28



Curved Explosion Vent Panel



Explosion Isolation Valve



Diverter

OUR DEVICES

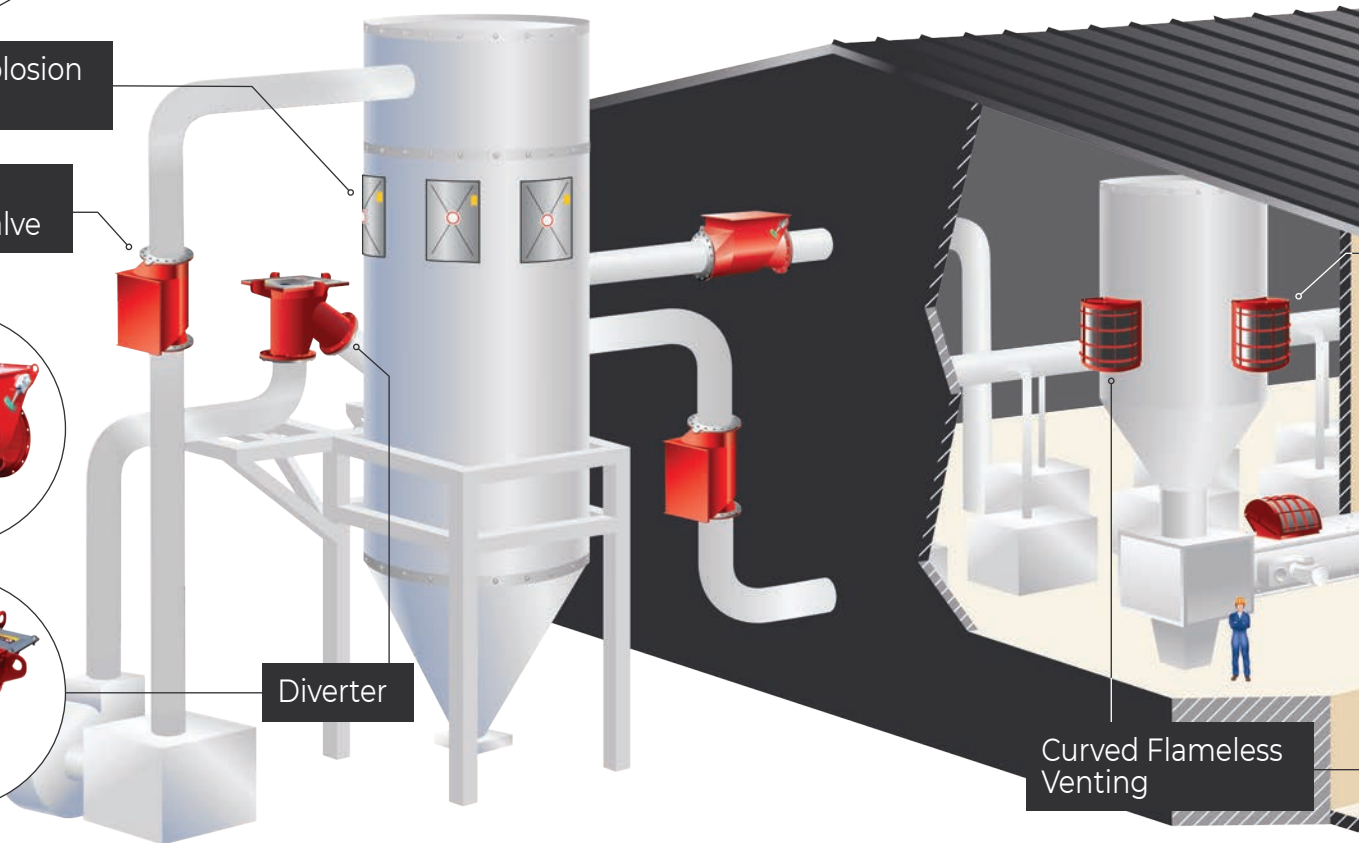

Curved Flameless Venting



Explosion Vent Panel

NEW

VIGILEX VL-HV&VL-R-HV *For high vacuum or working pressure*

30

NEW

VIGILEX ARC-VENT *Relieve arc explosions overpressure*

32



Pressure and Flame Guide

NEW

VIGISPACE *Deflector*

33

V-DEX *Diverter*

34

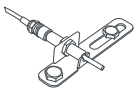

Accessories

BURST SENSOR

36

OPTIONS

37

www.vigilex.eu

38

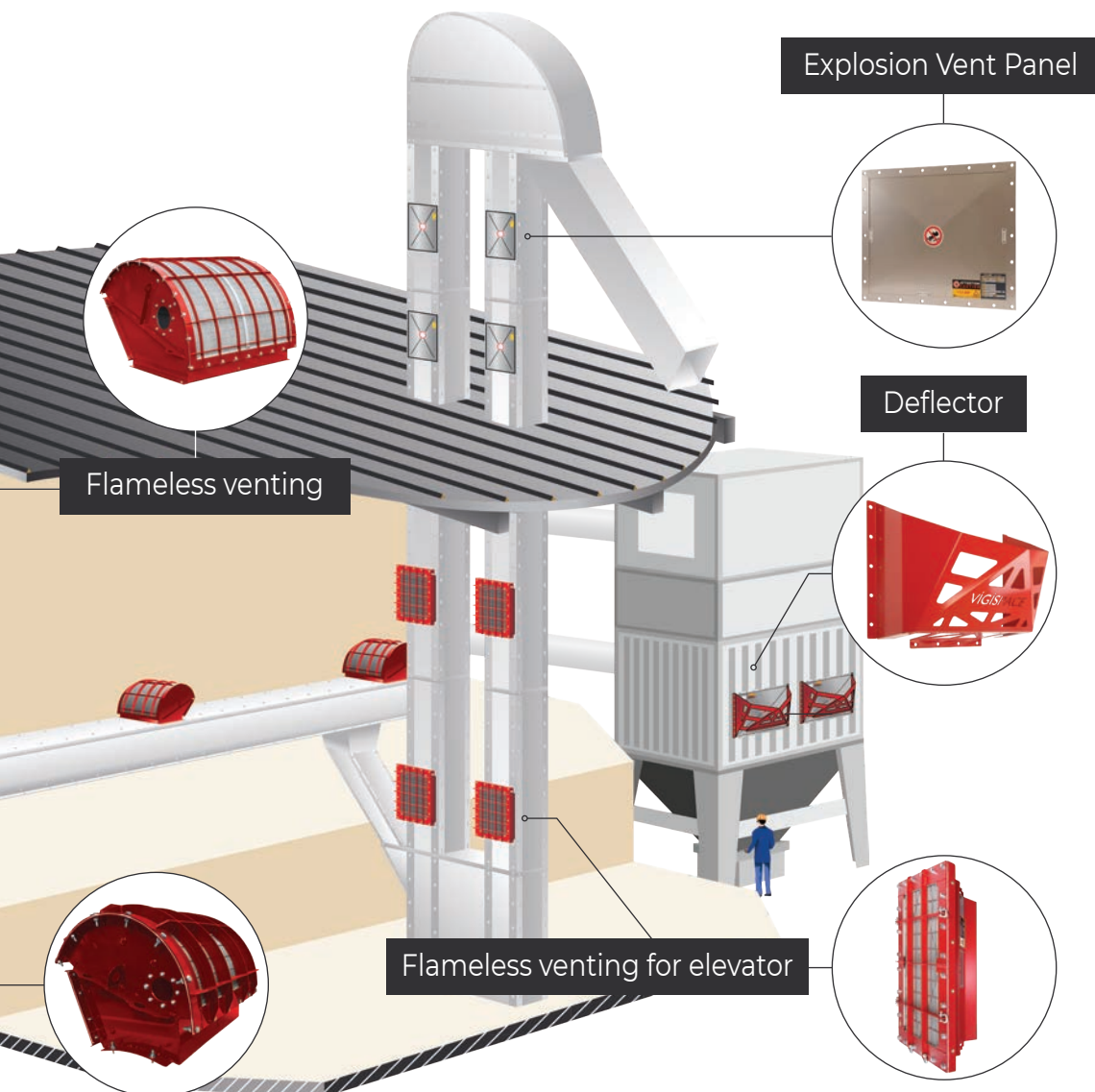

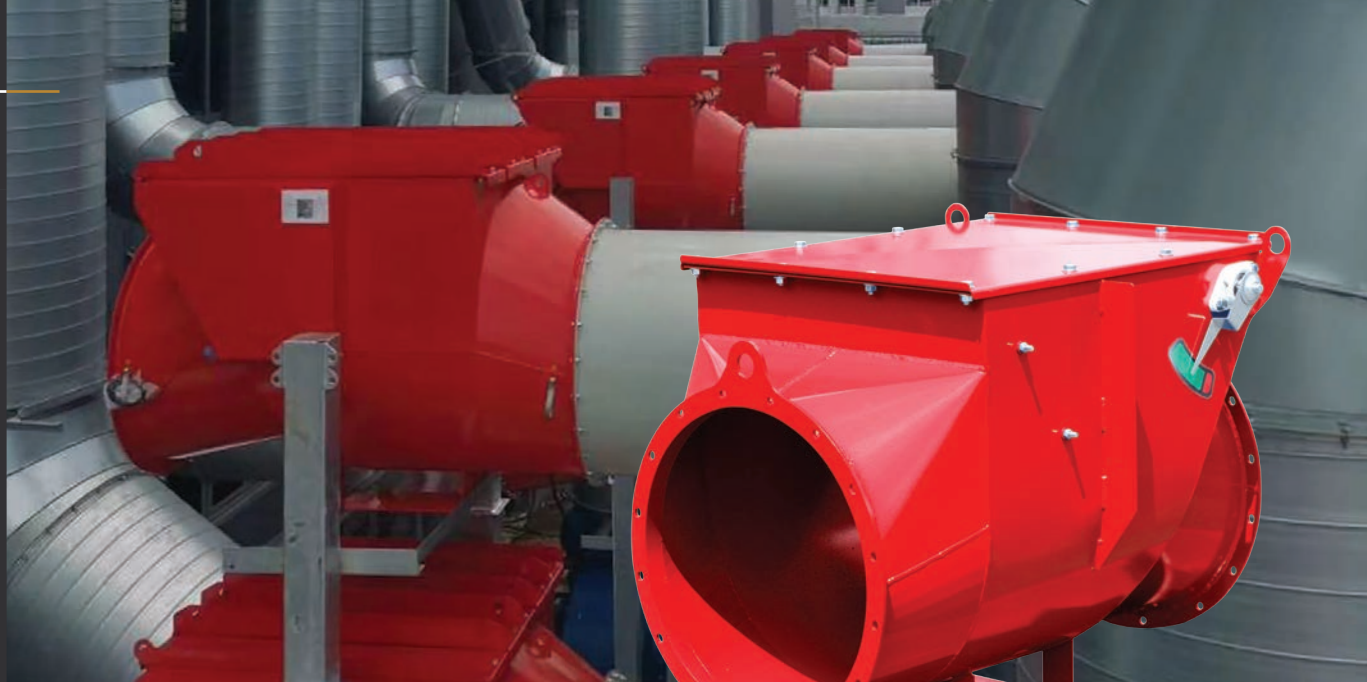

VIGIFLAP® EXPLOSION ISOLATION VALVE

APPLICATIONS

The **VigiFLAP** is a non-return valve designed to prevent overpressure or flame caused by a downstream explosion (dust collectors, filters, cyclones...) to propagate in the piping system.

The valve is held open by a lever arm. It can be used both at the entrance and at the exit of the filter. This allows to isolate the filter from an explosion or an overpressure.

In case of explosion, the valve closes and remains locked preventing the progress of the flame. The unlocking of the flap is done manually.

STANDARD CHARACTERISTICS

- Body: Painted steel
- Flap: Round domed flap: Stainless steel
- Diameter: \varnothing 160 mm to \varnothing 800 mm
- EPDM FDA Gasket:
-30°C to +70°C / -22°F to 158°F
- Flanges: ISO and ANSI flanges design
- Inductive Sensor: Non ATEX closing indication sensors in case of explosion or overpressure

CERTIFICATIONS

INERIS 19ATEX0016 X
EN 16447
EN 15089
NFPA 69



OPTIONS for VIGIFLAP

- Body: Metallic steel (zinc protection)
- Body: Stainless steel
- Gasket silicone FDA and 1935/2004 CE: -10°C to +180°C / 14°F to 356°F
- Counter-flange
- ATEX 21 closing indication sensors
- Capacitive sensor to warn dust accumulation (max: 70°C / 158°F)
- Connection box installed on the body, opposite side of the locking mechanism

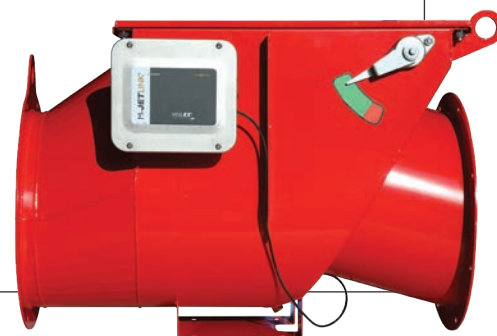

Explosion isolation valve **dimensions:**

VIGIFLAP®



SIZES & DISTANCE INSTALLATION

	DN (mm)	DN (inch)	Minimum Vessel Volume	L Min A* Min Mounting Distance	L Min B** Min Mounting Distance	L Max Max Mounting Distance	Installation position
VIGIFLAP Ø	100	4"	0,70 m³	5,0m	6,0m	17m	
VIGIFLAP Ø	130	5"	1,70 m³	5,0m	6,0m	17m	
VIGIFLAP Ø	160	6"	0,70 m³	4,0m	6,0m	17m	
VIGIFLAP Ø	160	6"	1,35 m³	3,0m	5,0m	17m	
VIGIFLAP Ø	180	7"	0,70 m³	4,0m	6,0m	17m	
VIGIFLAP Ø	180	7"	1,35 m³	3,0m	5,0m	17m	
VIGIFLAP Ø	200	8"	1,35 m³	4,6m	6,6m	17m	
VIGIFLAP Ø	250	10"	1,35 m³	4,0m	6,0m	17m	
VIGIFLAP Ø	300	12"	2,90 m³	4,6m	6,6m	17m	
VIGIFLAP Ø	350	14"	2,90 m³	4,2m	6,2m	17m	
VIGIFLAP Ø	400	16"	4,50 m³	5,2m	7,2m	17m	
VIGIFLAP Ø	450	18"	4,50 m³	4,7m	6,7m	17m	
VIGIFLAP Ø	500	20"	6,05 m³	5,8m	7,8m	17m	
VIGIFLAP Ø	550	22"	6,05 m³	5,5m	7,5m	17m	
VIGIFLAP Ø	600	24"	7,65 m³	7,2m	9,2m	17m	
VIGIFLAP Ø	650	26"	7,65 m³	6,7m	8,7m	17m	
VIGIFLAP Ø	700	28"	7,65 m³	6,4m	8,4m	17m	
VIGIFLAP Ø	750	30"	10,00 m³	7,3m	9,3m	17m	
VIGIFLAP Ø	800	32"	10,00 m³	6,9m	8,9m	17m	

* ■ Floating in horizontal position:
Flap valve activated by the working air flow

** ■ With elbows
 ■ Flap valve kept open by its spring blade system
 ■ Vertical position for VIGIFLAP ≥ ø160



Flap valve test with INERIS notified body

TECHNICAL INFORMATION

Kst max	≤250 bar.m/s	Pred max*	≤0.5bar	Air flow speed	Clean air side : ≤ 30 m/s Dirty air side : ≤ 45 m/s
Kst min	No limit	VIGIFLAP Resistance	2.0bar	Working	Air + dust circuit Clean air circuit
Pmax	10bar 145psi	Marque ATEX		Air flow range	Pull flow Push flow
MIE	≥10mJ	Atex inside	Zone 20 (II 1D)	Working pressure	500mbar max
MIT	≥ 400°C ≥ 752°F	Dust**	All dusts kinds	Working vacuum	-800mbar max
MESG	1,7mm 0.067inch	Dust concentration	No limit	Elbow quantity	No limit

*Vessel (potential explosion source)

**Organic dust, synthetic dust and metal dust

Features of the explosion isolation valve:

VIGIFLAP®  

NON DUST ACCUMULATION DESIGN

THE ALIGNMENT OF THE LOWER PART OF THE VIGIFLAP WITH THE PIPING, ALLOWS THE AIR FLOW TO CREATE A CONTINUOUS SELF-CLEANING, WITH LOW PRESSURE DROP



LOW PRESSURE LOSS

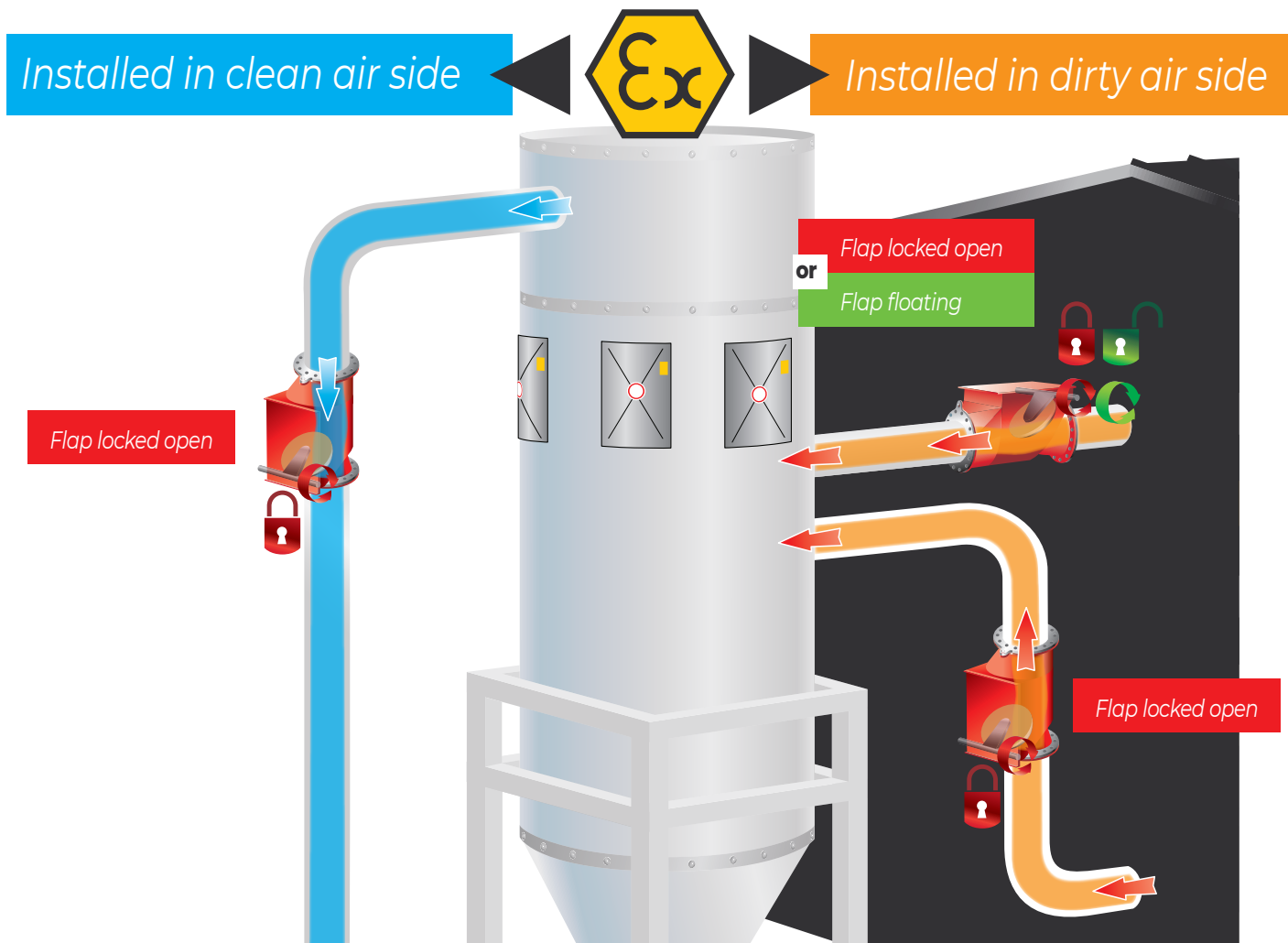

Process flow positions:

VIGIFLAP[®]  

PRODUCT PROCESS FLOW

1 Flap is held open by process flow

INSTALLATION
WITH
FLOATING FLAP

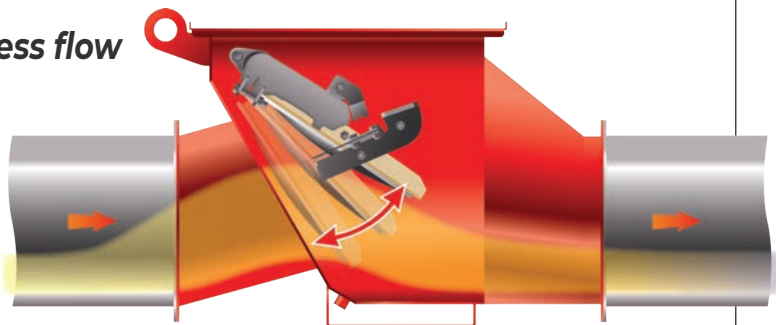

2 Flap locked in open position

INSTALLATION
WITH FLAP
LOCKED OPEN

Locked
open flap for
dirty airside

OR

Locked
open flap for
clean airside

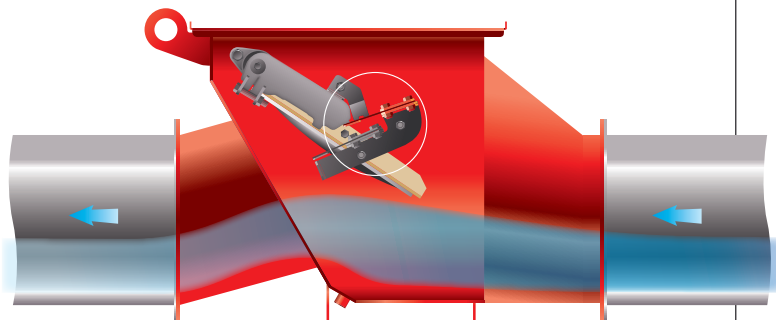
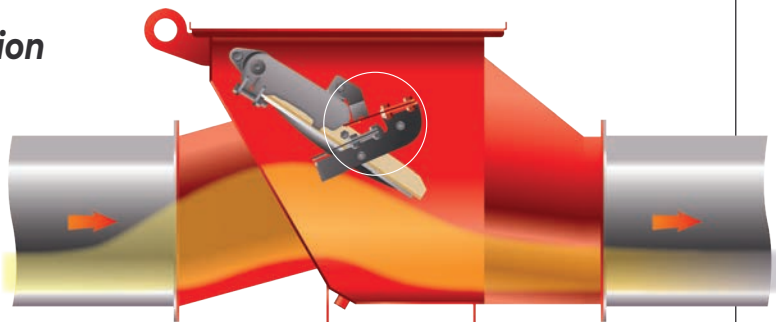

DURING AN EXPLOSION EVENT

Floating Flap or Locked Open Flap

Flap is closed by the explosion pressure wave and locked in place. Manual locking mechanism reset is required.



Positions and pressure drop curves:

VIGIFLAP POSITIONS

The vigiflap is the **first isolation** valve in the world to be certified for **horizontal and vertical** installation position

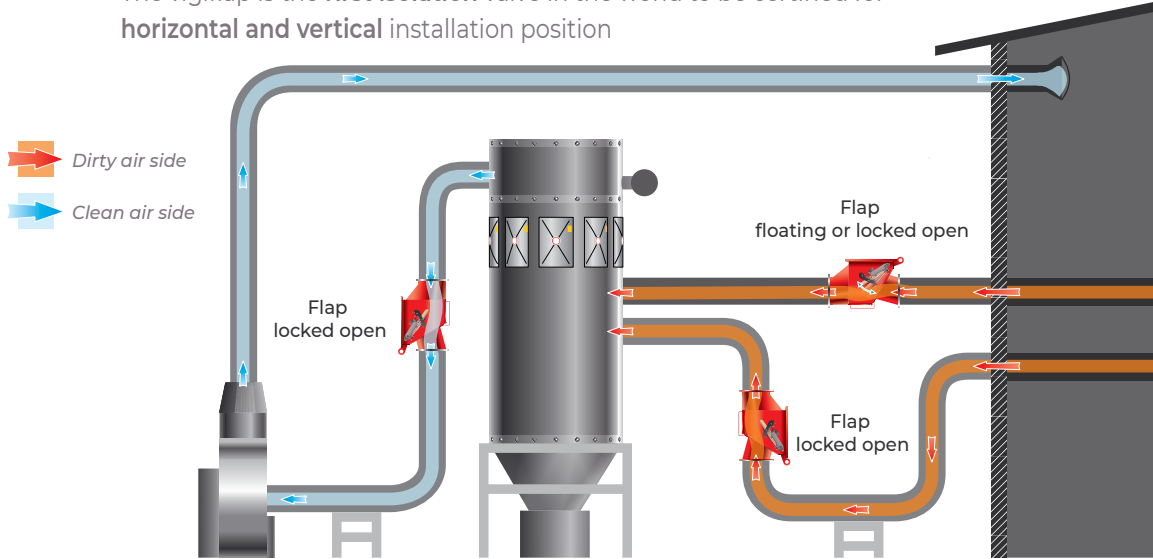

PRESSURE DROP CURVES

PRESSURE DROP/IN FLOW PROCESS (DIRTY AIR)

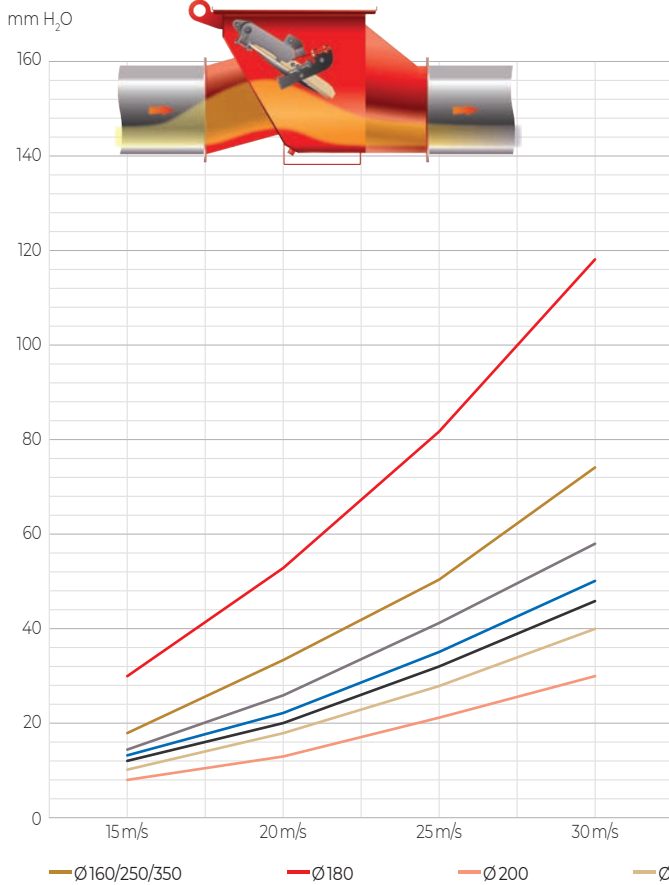

PRESSURE DROP/REVERSE PROCESS (CLEAN AIR)

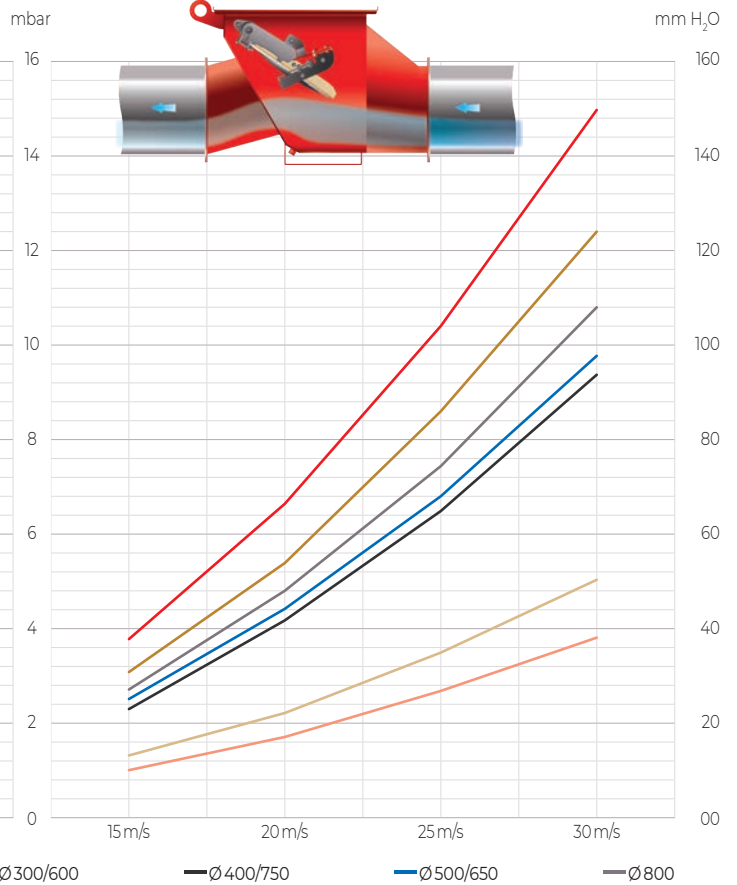

Certification:



INERIS 19ATEX0016X



HIGH CERTIFICATION TEST

To get our Atex certificate (N° INERIS 19ATEX0016X) according to the standard EN16447: 2014, we carried out our explosion tests in the most extreme conditions and as close as possible to the reality of the use of the product, with for example:

- **Protected Zone Pipeline :**
All test carried out with a pipeline after the flap (picture1).
- **Flap locked open :**
Automatic release of the valve by the pressure of the explosion
- **Floating flap :**
During the test the flap valve is held fully open until the appropriate time of release.
- **Vent panel on test vessel :**
No open ports were used during test but vent panels were always used.

CERTIFICATIONS EXPLOSION ISOLATION VALVE

- 2014/34/UE
- EN16447: 2014
- EN15089: 2009
- EN1127-1: 2019
- EN14460: 2018
- NFPA 69: 2019
- INERIS 08ATEXQ406
- ISO9001: 2015

SOON :

In few months our VIGIFLAP certificate will be improved with the following additional features Atex certified:

- **Size up to diameter 1370 mm**

10 m³ vessel
(All dust Kst250 bar.m/s)

VigiFLAP Ø800

The test and approval must reflect the intended use, in combination with a pipe.



(Picture1)



VIGIFLAM Vi® FLAMELESS

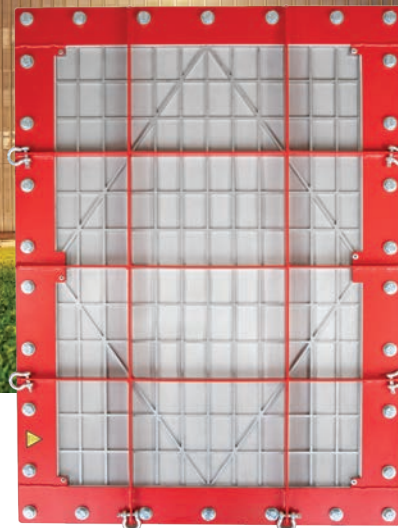

APPLICATIONS

The **flameless explosion venting device VIGIFLAM Vi** is designed in a rectangular shape and consists of three main components: the body, a metal filter composed of several layers to cool flames, and a new innovative explosion panel. This stainless steel membrane is weakened in the middle allowing to rupture when excessive overpressure occurs inside the enclosure intended to be protected.

The purpose of **VIGIFLAM Vi** is to neutralize the flame effects produced during an explosion, which would typically vent through a standard explosion panel. By containing the flames, it helps protect both people and property within a building or room.

VIGIFLAM Vi is specifically optimized for conveyors - bucket, belt, chain, and screw conveyors - due to its compact and efficient design, making it suitable for protecting such equipment in industrial settings.

STANDARD CHARACTERISTICS

- Vent panel
- Mild steel body + coating
- Stainless steel 304 mesh
- Integrated Silicone gasket
- Integrated burst sensor

CERTIFICATIONS

Ex II D
 EN 16009
 EC Certificate:
 GEX 24ATEX 1036X
 Production quality assurance notification:
 INERIS 08ATEXQ406

CERTIFIED FOR:

- Organic dust
- Fiber dust

OPTIONS for VIGIFLAM Vi

- Waterproof sanitary cover

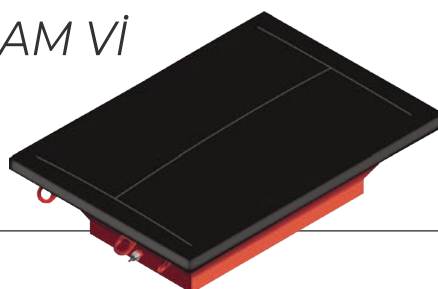

Flameless **dimensions:**



VIGIFLAM Vi®



GENERAL DIMENSIONS

VIGIFLAM Vi	NOMINAL PANEL SIZE		NOMINAL PANEL AREA		WEIGHT	FIXING BOLT
	(mm)	Pouces	m ²	sq ft	kg	Nbr
170 x 470	170 x 470	7 x 19	0.0799	0.845	29	16 M10
180 x 420	180 x 420	7 x 17	0.0756	0.795	28	16 M10
205 x 610	205 x 610	8 x 24	0.1251	1.320	38	20 M10
270 x 458	270 x 458	11 x 18	0.1237	1.315	40	18 M10
305 x 610	305 x 610	12 x 24	0.1861	1.980	55	22 M10
350 x 650	350 x 650	14 x 26	0.2275	2.420	67	22 M10
490 x 590	490 x 590	19 x 23	0.2891	3.085	80	26 M10



VIGIFLAM Vi

VIGIFLAM VQ

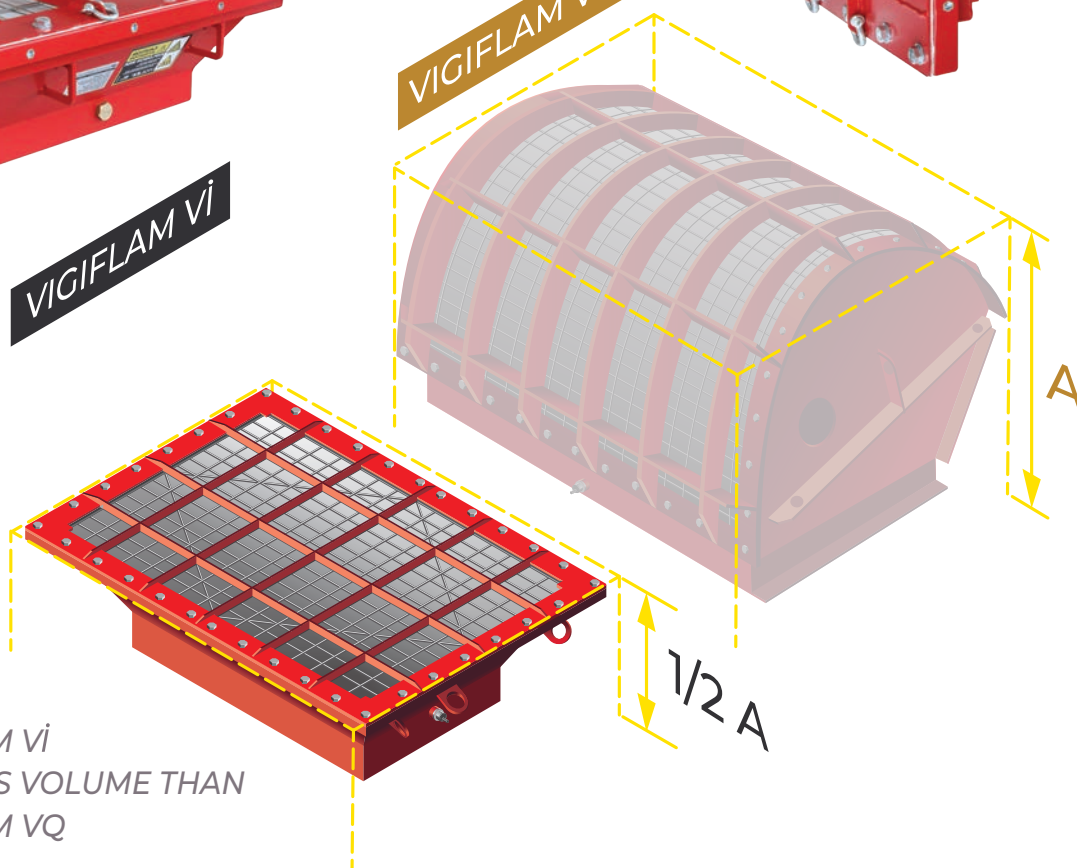

THE VIGIFLAM Vi
HAS 50% LESS VOLUME THAN
THE VIGIFLAM VQ

TECHNICAL INFORMATION

VIGIFLAM Vi

Kst max ≤ 200

Pmax: 9,4 bar

Pred: 1 bar

Pstat ≤ 0,1 bar (±20%)

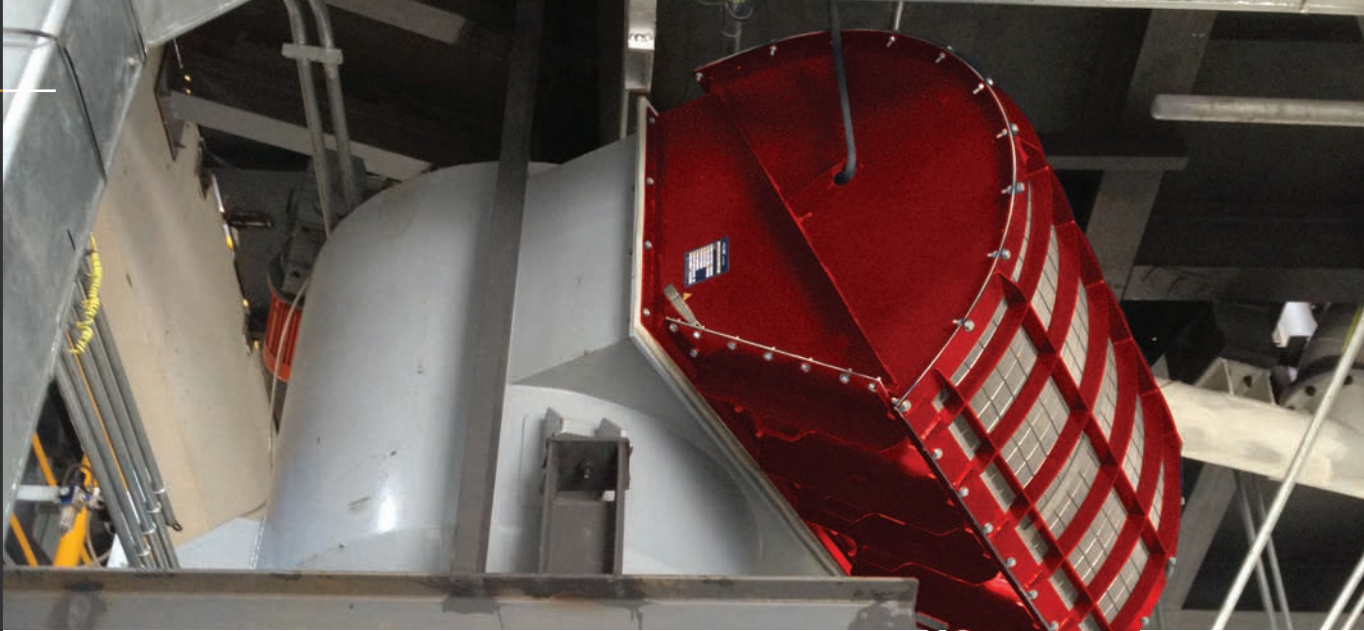

VIGIFLAMVQ® FLAMELESS VENTING APPLICATIONS

The VIGIFLAM VQ is a rectangular flameless device connected with an internal standard panel VIGIFLAM bursting panel.

It can be used with great effect indoors and outdoors and is a fast and easy solution instead of cumbersome and expensive solutions with pipe installations to the open air.

VIGIFLAM VQ can eliminate the spread of flame and glowing particles. During the early stage of an explosion the explosion vent opens. The flame, burned and unburned dust enter the flame arrester element. Flame propagation beyond the VQ is prevented by energy dissipation in the filter element, reducing the burning fuel below its ignition temperature.

The dust is retained within the VQ and gases from the explosion are vented through the device into the external atmosphere around the device.

STANDARD CHARACTERISTICS

- VL flat vent panel or VD domed vent panel included
- Mild steel body + coating
- Stainless steel mesh
- Burst sensor VIGILEX INR included

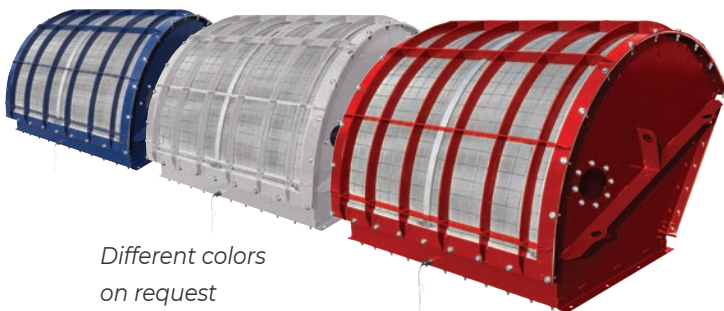

Different colors on request

CERTIFICATIONS

Ex II GD
Ex II 2 D

EN 16009

EC Certificate: INERIS 14ATEX0049X

Production quality assurance notification:
INERIS 08ATEXQ406

CERTIFIED FOR:

- Organic dust
- Fiber dust
- Gas



ACCESSORIES for VIGIFLAM VQ

- Waterproof Sanitary cover



- Body made of stainless steel (See page 19)

Flameless dimensions: **VIGIFLAM VQ LW**[®] Light weight - Pred: 0,5 bar
VIGIFLAM VQ HW[®] Heavy weight - Pred: 2,3 bar

FLAMELESS

VIGIFLAM VQ SPECIFICATIONS

VIGIFLAM VQ		IN COMBINATION WITH VENT PANEL				BOLT SPECS	
MODEL		Nominal Size (mm/inch)		Nominal Square (m ² /ft ²)		Qty	Size
VIGIFLAM VQ	170x470	170 x 470 mm	7 x 19 in	0,0785 m ²	0,845 sq ft	20	M10 x 30
VIGIFLAM VQ	270x458	270 x 458 mm	11 x 18 in	0,1220 m ²	1,315 sq ft	22	M10 x 30
VIGIFLAM VQ	300x500	300 x 500 mm	12 x 20 in	0,1480 m ²	1,595 sq ft	24	M10 x 30
VIGIFLAM VQ	305x610	305 x 610 mm	12 x 24 in	0,1840 m ²	1,980 sq ft	26	M10 x 30
VIGIFLAM VQ	350x650	350 x 650 mm	14 x 26 in	0,2250 m ²	2,425 sq ft	26	M10 x 30
VIGIFLAM VQ	490x590	490 x 590 mm	19 x 23 in	0,2865 m ²	3,084 sq ft	32	M10 x 30
VIGIFLAM VQ	610x610	610 x 610 mm	24 x 24 in	0,3695 m ²	3,975 sq ft	32	M10 x 30
VIGIFLAM VQ	457x890	457 x 890 mm	18 x 35 in	0,4040 m ²	4,349 sq ft	34	M10 x 30
VIGIFLAM VQ	586x920	586 x 920 mm	23 x 36 in	0,5360 m ²	5,770 sq ft	42	M10 x 30
VIGIFLAM VQ	645x1130	645 x 1130 mm	25 x 44 in	0,7250 m ²	7,804 sq ft	34	M10 x 30
VIGIFLAM VQ	920x920	920 x 920 mm	36 x 36 in	0,8425 m ²	9,068 sq ft	50	M10 x 30
VIGIFLAM VQ	1130x1130	1130 x 1130 mm	44 x 44 in	1,2720 m ²	13,696 sq ft	58	M10 x 30

TECHNICAL INFORMATION

VIGIFLAM VQ LW	Kst max 500	Pmax ≤ 10 bar	Pred ≤ 0,5 bar	Pstat = 0,1 to 0,3 bar
VIGIFLAM VQ HW	Kst max 500	Pmax ≤ 10 bar	Pred ≤ 2,3 bar*	Pstat = 0,1 to 0,5 bar

*Pred < 1,85 for VQ > 586x920

ADVANTAGES

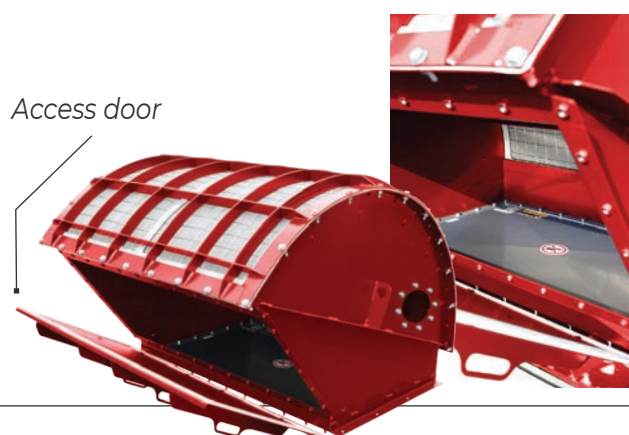
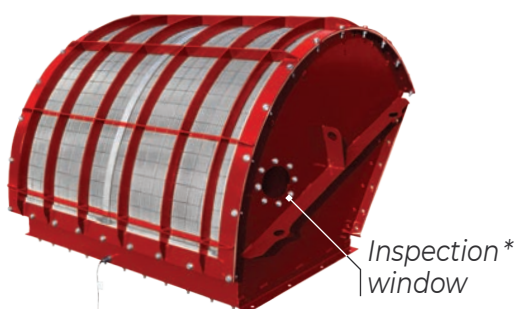

* Only available on VQ LW

Flameless **curved**:

VIGIFLAM VQ-R®

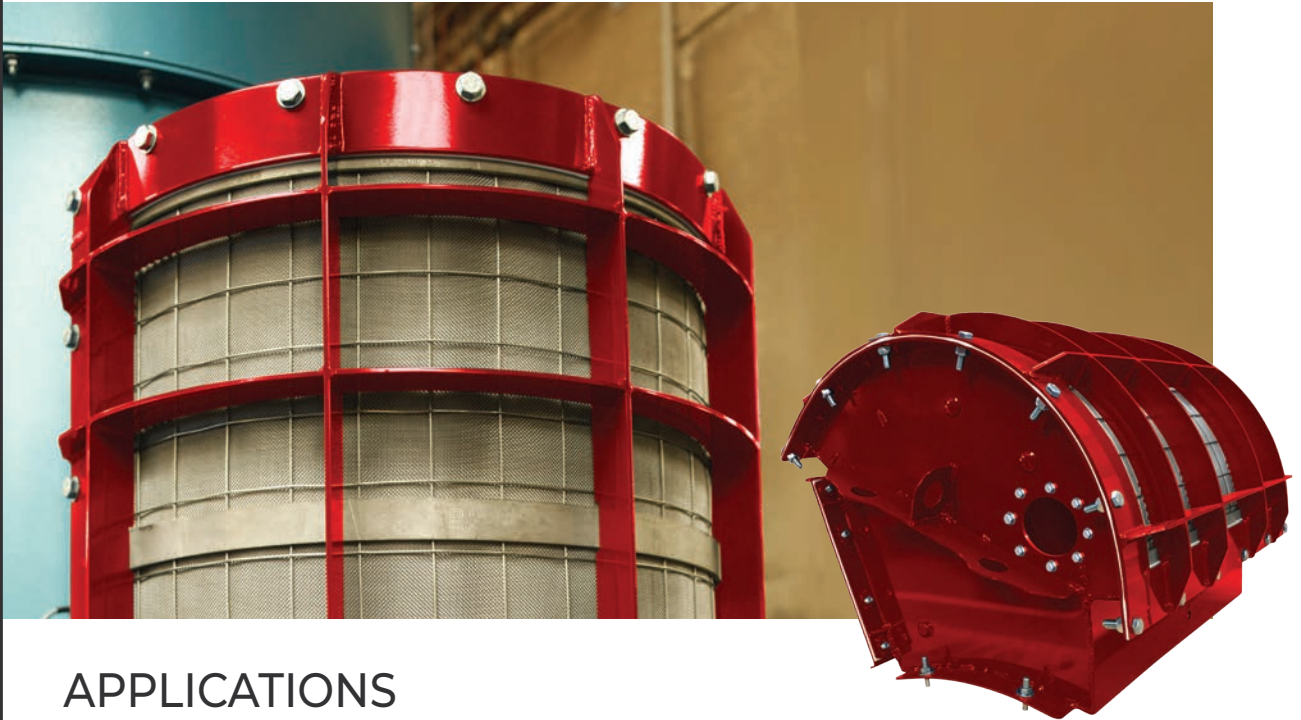

APPLICATIONS

The VIGIFLAM VQ curved is a rectangular flameless device connected with a standard bursting panel VIGIFLAM VL-R.

This curved flameless device can be installed directly on cylindrical vessels.

Thereby avoiding the possibility of a material accumulation in front of the explosion panel.

STANDARD CHARACTERISTICS

- VL-R Vent panel with EPDM gasket included
- Mild steel body + coating
- Stainless steel mesh
- Burst sensor VIGILEX INR included
- Sizes page 17
- Radius on request

OPTION

- Silicon gasket

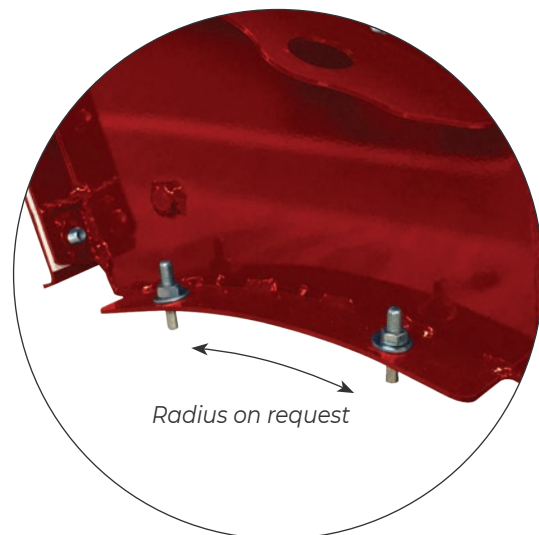

ACCESSORIES for VIGIFLAM VQ curved

- Waterproof Sanitary cover



Flameless **stainless steel**:

VIGIFLAM VQ-SST[®]

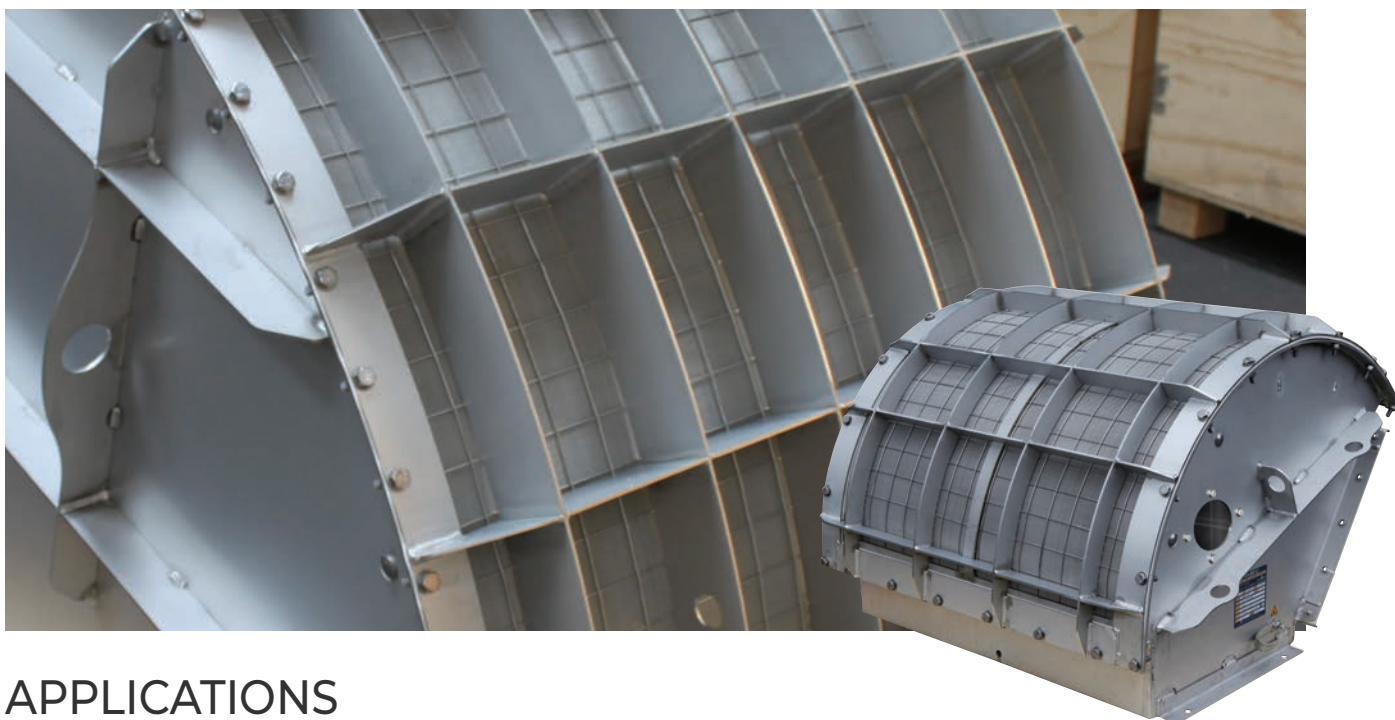

APPLICATIONS

The **VIGIFLAM VQ** stainless steel is a rectangular flameless device connected with a standard **VIGILEX** bursting panel. It is a perfect option for food or pharmaceutical facilities or installed in a moist atmosphere.

VIGIFLAM VQ stainless steel provides effective pressure resistance, eliminating the spread of flame and glowing particles.

STANDARD CHARACTERISTICS

- VL or VD Vent panel with silicone gasket included
- Stainless steel body
- Stainless steel mesh
- Burst sensor VIGILEX INR included

ACCESSORIES for VIGIFLAM VQ stainless steel

- Waterproof Sanitary cover





VIGILEX[®] VL VACUUM RESISTANCE: 50 MBAR

APPLICATIONS

The VIGILEX VL is suitable for all applications with low vacuum or working pressure (up to 50% of static burst pressure) such as elevators, conveyors, silos, cyclones.

With an integral flange ready to install, covering the breaking point, the VIGILEX VL ensures a strong mechanical durability. The attached wide gasket provides the VIGILEX VL a perfect dust-proof seal.

The standard burst pressure is 0,1 bar (max. 0,5 bar) at 22° C (72° F).

STANDARD CHARACTERISTICS

- Design: Single flat sst 304 L
- Fully frame black EPDM gasket (-40°+80°C)
- Integrated stainless steel flange

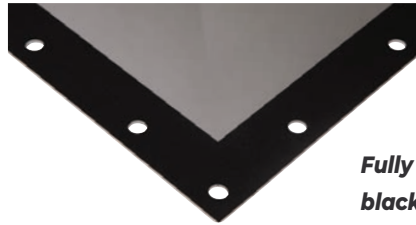

**Fully frame
black EPDM gasket (-40°+80°C)**

OPTIONS

- Panel material stainless steel 316L
- Fully frame white silicone FDA gasket and 1935/2004 CE (-60°+200°C)
- High temperature graphite gasket (-200°+500°C)
- Integrated stainless steel 316L flange

CERTIFICATIONS

Ex II GD

EN14 491

EN14 994

EN14 797

EN11271

EU Certificate: INERIS 15ATEX0001X

Production quality assurance notification:

INERIS 08ATEXQ406



ACCESSORIES for VIGILEX VL (See pages 36-37)

- Burst Sensor
- Weather protection vigilex WI
- Vacuum safety grid
- Duct discharge

Explosion vent panel **dimensions:**



RECTANGULAR & SQUARE

INTERNAL DIMENSION		EXTERNAL DIMENSION	AREA
(mm)	Inches	(mm)	(cm ²)
110 x 290	4 x 11	174 x 354	290
150 x 600	6 x 24	230 x 680	885
170 x 470	7 x 19	250 x 550	785
220 x 420	9 x 17	300 x 500	910
229 x 229	9 x 9	310 x 310	515
229 x 305	9 x 12	310 x 386	690
247 x 610	10 x 24	327 x 690	1485
270 x 458	11 x 18	350 x 538	1220
300 x 500	12 x 20	380 x 580	1480
300 x 600	12 x 24	366 x 666	1605
305 x 457	12 x 18	386 x 538	1385
305 x 610	12 x 24	386 x 690	1845
319 x 765	12 x 30	405 x 850	2480
340 x 385	13 x 15	404 x 449	1250
340 x 440	13 x 17	404 x 504	1430
350 x 650	14 x 26	430 x 730	2255
375 x 655	15 x 25	460 x 740	2445
390 x 620	15 x 24	470 x 700	2395
410 x 410	16 x 16	480 x 480	1660
420 x 520	16 x 20	500 x 600	2165
420 x 920	16 x 36	500 x 1000	3835
457 x 890	20 x 28	537 x 970	4040
470 x 610	18 x 24	550 x 690	2845
480 x 680	19 x 27	580 x 780	3260
490 x 490	19 x 19	570 x 570	2380
490 x 590	19 x 23	570 x 670	2865

INTERNAL DIMENSION		EXTERNAL DIMENSION	AREA
(mm)	Inches	(mm)	(cm ²)
520 x 520	20 x 20	600 x 600	2680
520 x 620	20 x 24	600 x 700	3200
520 x 1020	20 x 40	600 x 1000	5270
580 x 780	23 x 30	670 x 870	4495
580 x 1180	23 x 46	670 x 1270	6805
586 x 920	23 x 36	666 x 1000	5360
610 x 610	24 x 24	690 x 690	3695
610 x 1118	24 x 44	690 x 1198	6785
645 x 645	25 x 25	740 x 740	4130
645 x 1130	25 x 44	735 x 1220	7250
653 x 653	26 x 26	740 x 740	4260
680 x 680	27 x 27	780 x 780	4595
720 x 1020	28 x 40	800 x 1100	7300
780 x 780	30 x 30	880 x 880	6080
780 x 1180	30 x 46	880 x 1280	9160
800 x 1000	31 x 40	890 x 1090	7960
880 x 880	35 x 35	980 x 980	7700
915 x 1118	36 x 44	996 x 1198	10200
920 x 920	36 x 36	1000 x 1000	8425
980 x 980	39 x 39	1080 x 1080	9600
1000 x 1000	40 x 40	1056 x 1056	9680
1020 x 1020	40 x 40	1100 x 1100	10360
1080 x 1080	42 x 42	1180 x 1180	11600
1130 x 1130	44 x 44	1220 x 1220	12720
1180 x 1180	46 x 46	1280 x 1280	13875
1000 x 2000	40 x 79	1080 x 2080	19940

Other sizes available

ROUND

INTERNAL DIMENSION		EXTERNAL DIMENSION	AREA
(mm)	Inches	(mm)	(cm ²)
Ø 200	8	Ø 268	310
Ø 250	10	Ø 341	480
Ø 300	12	Ø 390	695
Ø 350	14	Ø 424	930
Ø 400	16	Ø 473	1230
Ø 450	18	Ø 545	1580
Ø 500	20	Ø 574	1935

INTERNAL DIMENSION		EXTERNAL DIMENSION	AREA
(mm)	Inches	(mm)	(cm ²)
Ø 600	24	Ø 676	2790
Ø 700	28	Ø 790	3830
Ø 750	30	Ø 842	4400
Ø 800	31	Ø 880	5000
Ø 900	36	Ø 980	6280
Ø 980	39	Ø 1070	7510

Other sizes available

TRAPEZOIDAL (On request)

TECHNICAL INFORMATION

STIF MODEL	DESIGN	Pstat @ 22 °C	EFFICIENCY RATIO	MAX VACUUM	KST MAX
VL	Single flat Integrated frame	100 ≤ Pstat ≤ 500 (±15%) Pstat < 100 (±20%)	80 % - 100 %	50 mbar	500 bar.m/s



VIGILEX VL-R®

VACUUM RESISTANCE:

-5 MBAR TO 50 MBAR DEPENDING ON DIMENSIONS

APPLICATIONS

The **VIGILEX VL-R** is a curved explosion vent panel shaped according to a customer specification need. **VIGILEX VL-R** is suitable for all applications with low vacuum or working pressure (up to 50 % of static burst pressure) such as elevators, conveyors, silos, cyclones.

With an integral flange ready to install, covering the breaking point, the **VIGILEX VL-R** ensures a strong mechanical durability. The attached wide gasket provides the **VIGILEX VL-R** a perfect dust-proof seal. The standard burst pressure is **0.1 bar (max. 0.5 bar) at 22°C (72°F)**.

The **VIGILEX VL-R** is tested after it has been formed, to ensure that the correct burst pressure is observed.

STANDARD CHARACTERISTICS

- Design: Single flat sst 304 L
- Fully frame black EPDM gasket (-40°+80°C)
- Integrated stainless steel flange
- Curved: radius on request

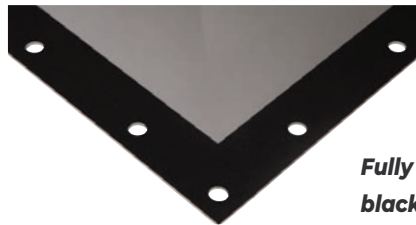

**Fully frame
black EPDM gasket (-40°+80°C)**

OPTIONS

- Panel material stainless steel 316L
- Fully frame white silicone FDA gasket and 1935/2004 CE (-60°+200°C)
- High temperature graphite gasket (-200°+500°C)
- Integrated stainless steel 316L flange

CERTIFICATIONS

Ex II GD

EN14 491

EN14 994

EN14 797

EN1127.1

EU Certificate: *INERIS 15ATEX0001X*

Production quality assurance notification:

INERIS 08ATEXQ406



ACCESSORIES for VIGILEX VL-R *(See pages 36-37)*

- Burst Sensor
- Weather protection vigilex WI
- Vacuum safety grid
- Duct discharge

Explosion vent panel dimensions:
VIGILEX VL-R[®]  
RECTANGULAR & SQUARE

INTERNAL DIMENSION		EXTERNAL DIMENSION	AREA
(mm)	Inches	(mm)	(cm ²)
110 x 290	4 x 11	174 x 354	290
150 x 600	6 x 24	230 x 680	885
170 x 470	7 x 19	250 x 550	785
220 x 420	9 x 17	300 x 500	910
229 x 229	9 x 9	310 x 310	515
229 x 305	9 x 12	310 x 386	690
247 x 610	10 x 24	327 x 690	1485
270 x 458	11 x 18	350 x 538	1220
300 x 500	12 x 20	380 x 580	1480
300 x 600	12 x 24	366 x 666	1605
305 x 457	12 x 18	386 x 538	1385
305 x 610	12 x 24	386 x 690	1845
319 x 765	12 x 30	405 x 850	2480
340 x 385	13 x 15	404 x 449	1250
340 x 440	13 x 17	404 x 504	1430
350 x 650	14 x 26	430 x 730	2255
375 x 655	15 x 25	460 x 740	2445
390 x 620	15 x 24	470 x 700	2395
410 x 410	16 x 16	480 x 480	1660
420 x 520	16 x 20	500 x 600	2165
420 x 920	16 x 36	500 x 1000	3835
457 x 890	20 x 28	537 x 970	4040
470 x 610	18 x 24	550 x 690	2845
480 x 680	19 x 27	580 x 780	3260
490 x 490	19 x 19	570 x 570	2380
490 x 590	19 x 23	570 x 670	2865

INTERNAL DIMENSION		EXTERNAL DIMENSION	AREA
(mm)	Inches	(mm)	(cm ²)
520 x 520	20 x 20	600 x 600	2680
520 x 620	20 x 24	600 x 700	3200
520 x 1020	20 x 40	600 x 1000	5270
580 x 780	23 x 30	670 x 870	4495
580 x 1180	23 x 46	670 x 1270	6805
586 x 920	23 x 36	666 x 1000	5360
610 x 610	24 x 24	690 x 690	3695
610 x 1118	24 x 44	690 x 1198	6785
645 x 645	25 x 25	740 x 740	4130
645 x 1130	25 x 44	735 x 1220	7250
653 x 653	26 x 26	740 x 740	4260
680 x 680	27 x 27	780 x 780	4595
720 x 1020	28 x 40	800 x 1100	7300
780 x 780	30 x 30	880 x 880	6080
780 x 1180	30 x 46	880 x 1280	9160
800 x 1000	31 x 40	890 x 1090	7960
880 x 880	35 x 35	980 x 980	7700
915 x 1118	36 x 44	996 x 1198	10200
920 x 920	36 x 36	1000 x 1000	8425
980 x 980	39 x 39	1080 x 1080	9600
1000 x 1000	40 x 40	1056 x 1056	9680
1020 x 1020	40 x 40	1100 x 1100	10360
1080 x 1080	42 x 42	1180 x 1180	11600
1130 x 1130	44 x 44	1220 x 1220	12720
1180 x 1180	46 x 46	1280 x 1280	13875
1000 x 2000	40 x 79	1080 x 2080	19940

Other sizes available
TECHNICAL INFORMATION

STIF MODEL	DESIGN	Pstat @ 22 °C	EFFICIENCY RATIO	MAX VACUUM	KST MAX
VL-R	Single flat Integrated frame	200 < Pstat ≤ 500 (±20%) Pstat ≤ 200 (±25%)	80 % - 100 %	50 mbar	500 bar.m/s



VIGILEX VL-SANITARY® VACUUM RESISTANCE: 50 MBAR

APPLICATIONS

The new **VIGILEX VL-SANITARY** is designed especially for hygienic applications in food or pharmaceutical industry. Dedicated to protect systems with low vacuum or working pressure (up to 50% of static burst pressure) such as spray dryers.

The high technology designed of this panel avoids contaminations.

The standard burst pressure is **0.1bar (max. 0.5bar) at 22°C (72°F)**.

STANDARD CHARACTERISTICS

- Design: Single flat stainless steel 316 L
- Food approved Blue FKM gasket (-10°+250°C):
 - FDA
 - 1935/2004CE
- Integrated stainless steel 316L flange
- Clean design
- Bacteriological barrier



TYPE EL CLASS I

CERTIFICATIONS

Ex II GD

EN14 491

EN14 994

EN14 797

EN1127.1

EU Certificate: *INERIS 15ATEX0001X*

EHEDG certicate: *C1900020*

Production quality assurance notification:

INERIS 08ATEXQ406



ACCESSORIES for VIGILEX VL-SANITARY (See pages 36-37)

- Burst Sensor
- Weather protection vigilex WI
- Duct discharge

Explosion vent panel
dimensions:

VIGILEX VL-SANITARY[®]  

RECTANGULAR & SQUARE

INTERNAL DIMENSION		EXTERNAL DIMENSION		AREA
(mm)	Inches	(mm)	(mm)	(cm ²)
610 x 610	24 x 24	690 x 690		3695
586 x 920	23 x 36	666 x 1000		5360
782 x 882	31 x 35	990 x 890		6790
920 x 920	36 x 36	1000 x 1000		8425
1020 x 1020	40 x 40	1100 x 1100		10360

TECHNICAL INFORMATION

STIF MODEL	DESIGN	Pstat @ 22 °C	EFFICIENCY RATIO	MAX VACUUM	KST MAX
VL-SANITARY	Single flat Integrated frame	200 < Pstat ≤ 500 (±20%) Pstat ≤ 200 (±25%)	80 % - 100 %	50 mbar	500 bar.m/s

MAKE YOUR
HYGIENIC PROCESS SAFE





VIGILEX[®]VD VACUUM RESISTANCE: 200 MBAR

APPLICATIONS

The VIGILEX VD is a domed panel, designed to protect plants with a vacuum and pulsating processes. The domed design is optimal for pneumatic operated vessels like filters and cyclones with strong vibration.

With an integral flange ready to install and gasket included, the VIGILEX VD meet all your safety issues with the most demand in your application. The attached wide gasket provides the VIGILEX VD a perfect dustproof. The standard burst pressure is **0.1 bar (max. 0.5 bar) at 22 °C (72 °F)**.

STANDARD CHARACTERISTICS

- Design: Single flat sst 304 L
- Fully frame black EPDM gasket (-40°+80°C)
- Integrated stainless steel flange

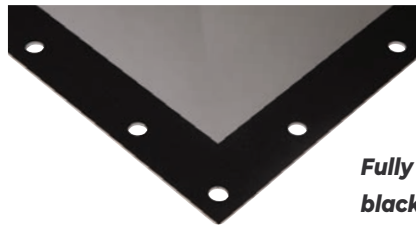

**Fully frame
black EPDM gasket (-40°+80°C)**

OPTIONS

- Panel material stainless steel 316L
- Fully frame white silicone FDA gasket and 1935/2004 CE (-60°+200°C)
- High temperature graphite gasket (-200°+500°C)
- Integrated stainless steel 316L flange

CERTIFICATIONS

Ex II GD

EN14 491

EN14 994

EN14 797

EN11271

EU Certificate: INERIS 15ATEX0001X

Production quality assurance notification:

INERIS 08ATEXQ406



ACCESSORIES for VIGILEX VD *(See pages 36-37)*

- Burst Sensor
- Weather protection vigilex WI
- Vacuum safety grid
- Duct discharge

Explosion vent panel **dimensions:**



RECTANGULAR & SQUARE

INTERNAL DIMENSION		EXTERNAL DIMENSION	AREA
(mm)	Inches	(mm)	(cm ²)
150 x 600	6 x 24	230 x 680	885
170 x 470	6 x 19	250 x 550	785
205 x 290	8 x 11	285 x 370	580
220 x 420	9 x 17	300 x 500	910
229 x 229	9 x 9	310 x 310	515
229 x 305	9 x 12	310 x 386	690
247 x 610	10 x 24	327 x 690	1485
270 x 458	11 x 18	350 x 538	1220
300 x 500	12 x 20	380 x 580	1480
305 x 457	12 x 18	386 x 538	1385
305 x 610	12 x 24	386 x 690	1845
340 x 385	13 x 15	404 x 449	1250
340 x 440	13 x 17	404 x 504	1430
350 x 650	14 x 26	430 x 730	2255
375 x 655	15 x 26	460 x 740	2445
410 x 410	16 x 16	480 x 480	1660

INTERNAL DIMENSION		EXTERNAL DIMENSION	AREA
(mm)	Inches	(mm)	(cm ²)
457 x 890	20 x 28	537 x 970	4040
470 x 610	18 x 24	550 x 690	2845
490 x 490	19 x 19	570 x 570	2380
490 x 590	19 x 23	570 x 670	2865
525 x 668	21 x 26	630 x 765	3400
586 x 920	23 x 36	666 x 1000	5360
610 x 610	24 x 24	690 x 690	3695
610 x 1118	24 x 44	690 x 1198	6785
645 x 645	25 x 25	735 x 735	4130
645 x 1130	25 x 44	735 x 1220	7250
653 x 653	26 x 26	740 x 740	4260
915 x 1118	36 x 44	996 x 1198	10200
920 x 920	36 x 36	1000 x 1000	8425
920 x 1380	36 x 54	1000 x 1460	12420
980 x 980	39 x 39	1080 x 1080	9600
1020 x 1020	40 x 40	1100 x 1100	10360

Other sizes available

ROUND

INTERNAL DIMENSION		EXTERNAL DIMENSION	AREA
(mm)	Inches	(mm)	(cm ²)
∅ 200	8	∅ 268	310
∅ 250	10	∅ 341	480
∅ 300	12	∅ 390	695
∅ 350	14	∅ 424	930
∅ 400	16	∅ 473	1230
∅ 450	18	∅ 545	1580
∅ 500	20	∅ 574	1935

INTERNAL DIMENSION		EXTERNAL DIMENSION	AREA
(mm)	Inches	(mm)	(cm ²)
∅ 600	24	∅ 676	2790
∅ 700	28	∅ 790	3830
∅ 750	30	∅ 842	4400
∅ 800	31	∅ 880	5000
∅ 900	36	∅ 980	6280
∅ 980	39	∅ 1070	7510
∅ 1200	47	∅ 1290	11766

Other sizes available

TECHNICAL INFORMATION

STIF MODEL	DESIGN	Pstat @ 22 °C	EFFICIENCY RATIO	MAX VACUUM	KST MAX
VD	Single domed Integrated frame	100 ≤ Pstat ≤ 500 (±15%) Pstat < 100 (±20%)	80 % - 100 %	200 mbar	500 bar.m/s

VIGILEX[®]VD-HV[®] VACUUM RESISTANCE: 200 - 500 MBAR

APPLICATIONS

The VIGILEX VD-HV is a strong domed panel, designed for use in applications where the operating pressure approaches the burst pressure, or where high vacuum pressure may exist. In the need for applications where the explosion vent is exposed to pulsating duty such as reverse jet cleaning systems on dust collectors with high vacuum.

With a large flange and gasket included, the one layer domed panel VIGILEX VD-HV meets all your safety issue to protect equipment and facilities. The standard burst pressure is **0.1 bar (max. 0.5 bar) at 22°C (72°F)**.

STANDARD CHARACTERISTICS

- Design: Single flat sst 304 L
- Fully frame black EPDM gasket (-40°+80°C)
- Integrated stainless steel flange

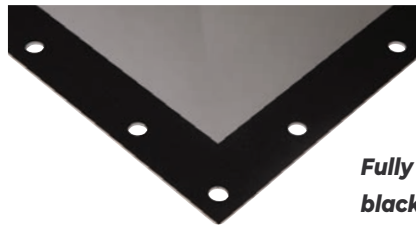

**Fully frame
black EPDM gasket (-40°+80°C)**

OPTIONS

- Panel material stainless steel 316L
- Fully frame white silicone FDA gasket and 1935/2004 CE (-60°+200°C)
- High temperature graphite gasket (-200°+500°C)
- Integrated stainless steel 316L flange

CERTIFICATIONS

Ex II GD

EN14 491

EN14 994

EN14 797

EN11271

EU Certificate: INERIS 15ATEX0001X

Production quality assurance notification:

INERIS 08ATEXQ406



ACCESSORIES for VIGILEX VD-HV (See pages 36-37)

- Burst Sensor
- Weather protection vigilex WI
- Vacuum safety grid
- Duct discharge

Explosion vent panel **dimensions:** VIGILEX[®] VD-HV[®]

RECTANGULAR & SQUARE

INTERNAL DIMENSION		EXTERNAL DIMENSION	AREA
(mm)	Pulgadas	(mm)	(cm ²)
150 x 600	6 x 24	230 x 680	885
170 x 470	6 x 19	250 x 550	785
205 x 290	8 x 11	285 x 370	580
220 x 420	9 x 17	300 x 500	910
229 x 229	9 x 9	310 x 310	515
229 x 305	9 x 12	310 x 386	690
247 x 610	10 x 24	327 x 690	1485
270 x 458	11 x 18	350 x 538	1220
300 x 500	12 x 20	380 x 580	1480
305 x 457	12 x 18	386 x 538	1385
305 x 610	12 x 24	386 x 690	1845
340 x 385	13 x 15	404 x 449	1250
340 x 440	13 x 17	404 x 504	1430

INTERNAL DIMENSION		EXTERNAL DIMENSION	AREA
(mm)	Pulgadas	(mm)	(cm ²)
350 x 650	14 x 26	430 x 730	2255
375 x 655	15 x 26	460 x 740	2445
410 x 410	16 x 16	480 x 480	1660
457 x 890	20 x 28	537 x 970	4040
470 x 610	18 x 24	550 x 690	2845
490 x 490	19 x 19	570 x 570	2380
490 x 590	19 x 23	570 x 670	2865
525 x 668	21 x 26	630 x 765	3400
586 x 920	23 x 36	666 x 1000	5360
610 x 610	24 x 24	690 x 690	3695
653 x 653	26 x 26	740 x 740	4260
920 x 920	36 x 36	1000 x 1000	8425

Other sizes available

ROUND

DIMENSIONS INTÉRIEURES		DIMENSIONS EXTÉRIEURES	SURFACE
(mm)	Inches	(mm)	(cm ²)
Ø 200	8	Ø 268	310
Ø 250	10	Ø 341	480
Ø 300	12	Ø 390	695
Ø 350	14	Ø 424	930
Ø 400	16	Ø 473	1230
Ø 450	18	Ø 545	1580
Ø 500	20	Ø 574	1935

DIMENSIONS INTÉRIEURES		DIMENSIONS EXTÉRIEURES	SURFACE
(mm)	Inches	(mm)	(cm ²)
Ø 600	24	Ø 676	2790
Ø 700	28	Ø 790	3830
Ø 750	30	Ø 842	4400
Ø 800	31	Ø 880	5000
Ø 900	36	Ø 980	6280
Ø 980	39	Ø 1070	7510
Ø 1200	47	Ø 1290	11766

Other sizes available

TECHNICAL INFORMATION

STIF MODEL	DESIGN	Pstat @ 22 °C	EFFICIENCY RATIO	MAX VACUUM	KST MAX
VD-HD	Single domed Integrated frame	100 ≤ Pstat ≤ 500 (±15%) Pstat < 100 (±20%)	80 % - 100 %	500 mbar	500 bar.m/s

NEW



VIGILEX VL-HV® & VL-R-HV® APPLICATIONS

VACUUM RESISTANCE:
100 MBAR TO 400 MBAR DEPENDING ON DIMENSIONS

The VIGILEX VL-HV* & VIGILEX VL-R-HV** is suitable for all applications with high vacuum or working pressure (50% of static burst pressure) such as cyclones, dust collectors...

With an integral flange ready to install, covering the breaking point, the VIGILEX VL-HV & VIGILEX VL-R-HV ensures a strong mechanical durability. The attached wide gasket provides the VIGILEX VL-HV & VIGILEX VL-R-HV a perfect dustproof seal.

The standard burst pressure is **0,1 bar at 22°C (72°F)**.

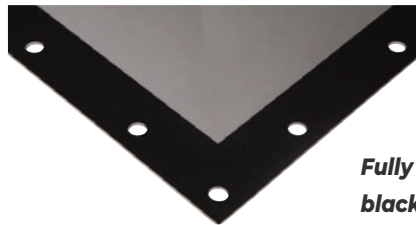

**Fully frame
black EPDM gasket (-40°+80°C)**

STANDARD CHARACTERISTICS

- *: Single flat sst 304L
- **: Curved panel sst 304L
- Fully frame black EPDM gasket (-40°+80°C)
- Integrated stainless steel flange

OPTIONS

- Panel material stainless steel 316L
- Fully frame white silicone FDA gasket and 1935/2004 CE (-60°+200°C)
- High temperature graphite gasket (-200°+500°C)
- Integrated stainless steel 316L flange

CERTIFICATIONS

Ex II GD
EN14 491
EN14 994
EN14 797
EN11271



EU Certificate: INERIS 15ATEX0001X

Production quality assurance notification:
INERIS 08ATEXQ406

ACCESSORIES for VIGILEX VL-HV & VL-R-HV (See pages 36-37)

- Burst Sensor
- Duct discharge

Explosion vent panel **dimensions:**

VIGILEX VL-HV® & VL-R-HV®

RECTANGULAR & SQUARE

INTERNAL DIMENSION		EXTERNAL DIMENSION	AREA
(mm)	Inches	(mm)	(cm ²)
110 x 290	4 x 11	174 x 354	290
150 x 600	6 x 24	230 x 680	885
170 x 470	7 x 19	250 x 550	785
220 x 420	9 x 17	300 x 500	910
229 x 229	9 x 9	310 x 310	515
229 x 305	9 x 12	310 x 386	690
247 x 610	10 x 24	327 x 690	1485
270 x 458	11 x 18	350 x 538	1220
300 x 500	12 x 20	380 x 580	1480
300 x 600	12 x 24	366 x 666	1605
305 x 457	12 x 18	386 x 538	1385
305 x 610	12 x 24	386 x 690	1845
319 x 765	12 x 30	405 x 850	2480
340 x 385	13 x 15	404 x 449	1250
340 x 440	13 x 17	404 x 504	1430
350 x 650	14 x 26	430 x 730	2255
375 x 655	15 x 25	460 x 740	2445
390 x 620	15 x 24	470 x 700	2395
410 x 410	16 x 16	480 x 480	1660
420 x 520	16 x 20	500 x 600	2165
420 x 920	16 x 36	500 x 1000	3835
457 x 890	20 x 28	537 x 970	4040
470 x 610	18 x 24	550 x 690	2845
480 x 680	19 x 27	580 x 780	3260
490 x 490	19 x 19	570 x 570	2380
490 x 590	19 x 23	570 x 670	2865

INTERNAL DIMENSION		EXTERNAL DIMENSION	AREA
(mm)	Inches	(mm)	(cm ²)
520 x 520	20 x 20	600 x 600	2680
520 x 620	20 x 24	600 x 700	3200
520 x 1020	20 x 40	600 x 1000	5270
580 x 780	23 x 30	670 x 870	4495
580 x 1180	23 x 46	670 x 1270	6805
586 x 920	23 x 36	666 x 1000	5360
610 x 610	24 x 24	690 x 690	3695
610 x 1118	24 x 44	690 x 1198	6785
645 x 645	25 x 25	740 x 740	4130
645 x 1130	25 x 44	735 x 1220	7250
653 x 653	26 x 26	740 x 740	4260
680 x 680	27 x 27	780 x 780	4595
720 x 1020	28 x 40	800 x 1100	7300
780 x 780	30 x 30	880 x 880	6080
780 x 1180	30 x 46	880 x 1280	9160
800 x 1000	31 x 40	890 x 1090	7960
880 x 880	35 x 35	980 x 980	7700
915 x 1118	36 x 44	996 x 1198	10200
920 x 920	36 x 36	1000 x 1000	8425
980 x 980	39 x 39	1080 x 1080	9600
1000 x 1000	40 x 40	1056 x 1056	9680
1020 x 1020	40 x 40	1100 x 1100	10360
1080 x 1080	42 x 42	1180 x 1180	11600
1130 x 1130	44 x 44	1220 x 1220	12720
1180 x 1180	46 x 46	1280 x 1280	13875

Other sizes available

TECHNICAL INFORMATION

STIF MODEL	DESIGN	Pstat @ 22 °C	EFFICIENCY RATIO	MAX VACUUM	KST MAX
VL-HV VL-R-HV	Single flat or curved Integrated frame	≤ 0,1 bar (±25%)	80 % - 100 %	100 à 400 mbar depending on size	500 bar.m/s

NEW



VIGILEX ARCVENT®

Ex CE

APPLICATIONS

The new VIGILEX ARC VENT range is specifically designed for installation on **BESS (Battery Energy Storage Systems)** and on external walls of electrical switch rooms to relieve overpressure caused by explosions due to gas explosion or arc flash.

These safety elements are certified and tested to open at the required pressure. They are generally installed on the roof of BESS containers to safely direct the explosion upwards and thus protect property and people. The ARC VENT panels are **IP66** and **ATEX EN 14994** certified.

ARCVENT®

STANDARD CHARACTERISTICS

- Designed single flat SST 304L
- **Grey silicone gasket UL 50 E - UL157**
- Arc Flange included gasket, no water retention and vibration resistant system



ARC-VENT®INS⁺A & INS⁻B

STANDARD CHARACTERISTICS

- INS-A Insulation foam glued below the membrane
- INS-B Insulation protection with Aluminum box
- Designed single flat SST 304L
- **Grey silicone gasket UL 50 E - UL157**
- Arc Flange includes gasket, no water retention and vibration resistant system



ARC-VENT®INS⁺MAX



STANDARD CHARACTERISTICS

- Design: one-piece pressed membrane with insulating foam armafex UL 94 VO integration
- All Stainless steel 304L
- Flange + gasket included
- **Grey silicone gasket UL 50 E - UL157**
- No water retention and vibration resistant



OPTIONS

- White Silicone (-60 °C +200°C)
- Black EPDM Gasket (-40°C +80°C)
- Flat Grid (not for INS-)
- Inductive Burst Sensor

CERTIFICATIONS

Ex II GD

IP66



EN14994
EN14797
EN11271

NF EN ISO 9227: 2012
NF EN 8993: 2010
NF EN 10289: 1999

EU Certificate: *INERIS 15ATEX0001X_Type VL*

Production quality assurance notification:
INERIS 08ATEXQ406

NEW



VIGISPACE®

VIGISPACE®  

APPLICATIONS

When an explosion occurs outdoors, the explosion vent opens fully and relieves the explosion pressure and flame in the surrounding environment. This can cause the explosion or fire to spread and affect buildings, vehicles or personnel.

In order to avoid this risk, we designed the **VIGISPACE** to guide the pressure and flame discharge and avoid collateral damages. In fact, the **VIGISPACE** will limit the opening angle of the explosion vent and guide the pressure, flame and heat relief up to upwards.

Advantage: By reducing the dimension of the hazardous surface, the **VIGISPACE** helps to reduce the safety zone to a minimum and increases the useful space of your installations, while ensuring maximum protection against explosions.

The **VIGISPACE** must be used with **VIGILEX VL** or **VD**.



Explosion with VIGISPACE



CHARACTERISTICS OF USE

KST, MAX	≤200 bar.m/s	PSTAT	≤0.5 bar
P _{MAX}	10 bar	HYDRAULIC DIAMETER	D _h ≤ 1.2m
PRED OF THE ENCLOSURE	≤0.7 bar	EFFICIENCY	60%

CERTIFICATIONS

Ex II D

EN14491

EN14797

EU Certificate:

INERIS 22ATEX0004X

Production quality assurance notification:

INERIS 08ATEXQ406





V-DEX® DIVERTER

APPLICATIONS

The V-DEX diverter is used to deflect explosions propagating through the ducts, preventing the spread of flames or overpressures in connected vessels.

This device reduces the risk of flame spread.

STANDARD CHARACTERISTICS

- Body: Painted steel
- Domed explosion vent panel VD

CERTIFICATIONS

Explosion Panel Certifications

EN14797

EN14491



OPTIONS for V-DEX

- Body: Stainless steel
- Duct discharge

Diverter dimensions:



CHARACTERISTICS OF THE EXPLOSION DEFLECTION DEVICE

Number of panels	∅	mm	inch	H1	H2	D1	D2	L1	L2	T	Panel dimensions
x1	∅ 200	8	150	555	200	410	410	410	410	685	VD 410x410
	∅ 250	10	175	600	250	490	490	490	490	781	VD 490x490
	∅ 300	12	200	700	300	610	610	610	610	875	VD 610x610
	∅ 350	14	225	800	350	645	645	645	645	975	VD 645x645
	∅ 400	16	250	900	400	780	780	780	780	1070	VD 780x780
x2	∅ 450	18	275	1000	450	850	920	920	920	1165	VD 457x890 (Qty. 2)
	∅ 500	20	300	1100	500	920	920	920	920	1260	VD 457x890 (Qty. 2)
	∅ 550	22	325	1200	550	980	980	980	980	1355	VD 457x890 (Qty. 2)
	∅ 600	24	350	1300	600	1070	1020	1020	1020	1455	VD 586x920 (Qty. 2)
	∅ 650	26	375	1400	650	1180	1180	1180	1180	1550	VD 586x920 (Qty. 2)
x4	∅ 700	28	400	1500	700	1250	1375	1130	1130	1645	VD 610x610 (Qty. 4)
	∅ 750	30	425	1600	750	1350	1455	1350	1350	1740	VD 610x610 (Qty. 4)
	∅ 800	32	450	1700	800	1430	1455	1350	1350	1835	VD 645x645 (Qty. 4)
	∅ 850	34	475	1800	850	1520	1605	1520	1520	1930	VD 586x920 (Qty. 4)
	∅ 900	36	500	1900	900	1600	1605	1520	1520	2030	VD 586x920 (Qty. 4)
x6	∅ 950	38	525	2000	950	1700	1785	1780	1780	2125	VD 457x890 (Qty. 6)
	∅ 1000	40	550	2100	1000	1780	1785	1780	1780	2220	VD 530x850 (Qty. 6)

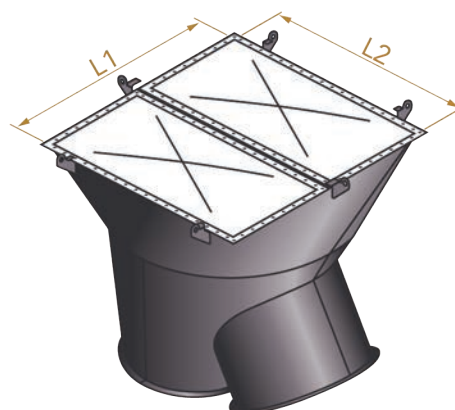
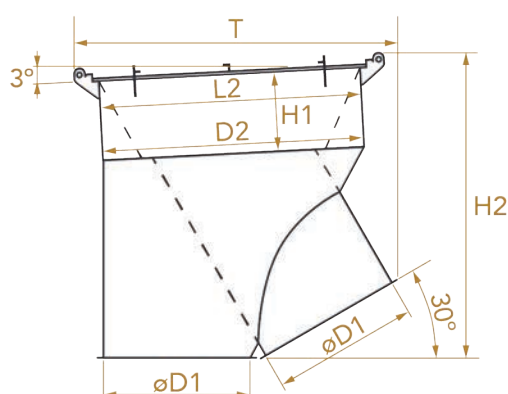

TECHNICAL INFORMATION

STIF MODEL	KST MAX	Pred. Max	PMAX	DUST
V-DEX	St2 ≤300 bar.m/s	0,8bar	≤12bar	Any kind of dust

BURST SENSOR

APPLICATIONS

The **BURST SENSOR** is a very efficient element to inform when your safety devices are open. Get the signal in realtime and increase the safety of your facilities.

VIGILEX INR
 Inductive proximity sensor
 Atex Zone 21
 Voltage: 12-48V DC

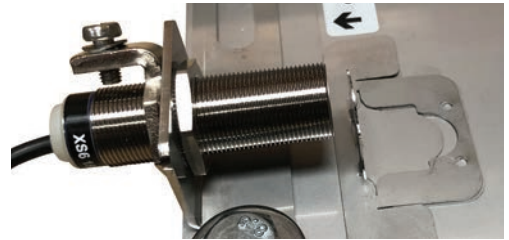

VIGILEX MEC
 Mechanical burst sensor
 Atex Zone 21
 Voltage: 12-240V AC/DC

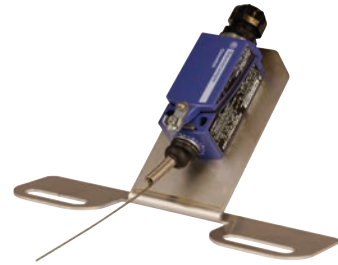

VIGILEX MAG
 Magnetic burst sensor
 Atex Zone 21
 Voltage: 12-60V DC



VIGILEX SEC
 Détecteur d'explosion sécable
 Atex Zone 21
 Tension: 12-24V DC

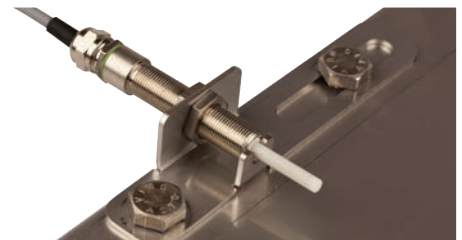

VIGILEX CAB
 Breakable cable burst sensor
 Voltage <ou = 1,5 DC
 Current <ou = 100 mA
 Power <ou = 25 mW



M-JET LINK
 Connection box
 Atex Zone 21
 To connect burst sensor and control unit



OTHERS ACCESSORIES

VIGILEX CAP

Discharge duct

Range of duct discharge in either galanised or stainless steel.



VIGILEX WI 100 (100 mm high) VIGILEX WI 40 (40 mm high)

Weather protection

This lightweight weather cover offers protection to the explosion vent panels from the elements with the effects of wind, snow, hail and dirt minimised.



VIGILEX GS, GD & GF

Vacuum safety grid

Range of fall and vacuum protection painted, galvanized or stainless steel.

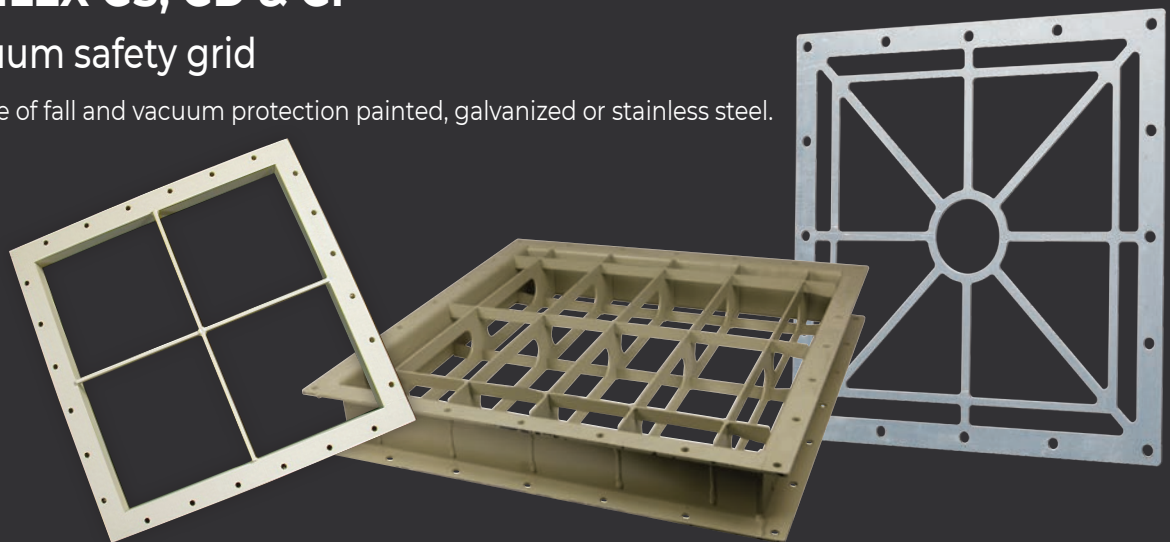

WWW.VIGILEX.EU

We give you the opportunity **to access to all our documents** (drawings, certificates, data sheets, brochures,...) on our website dedicated to our explosion protection system range.

Watch our videos



Access to our software for vent area calculation



Download drawings of all our products range

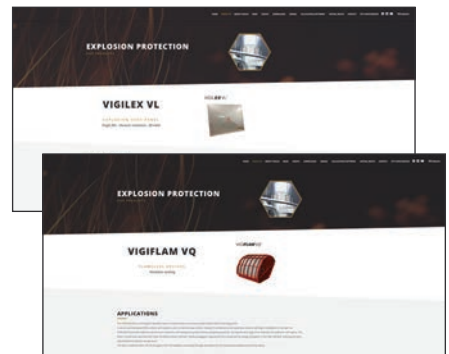

Download our certificates & questionnaires

Find all the accessories you need to increase the performance of your safety equipment

QUESTIONNAIRES

By filling in the questionnaire, we can propose a solution designed to your requirements and conforming to the standards **EN14991, EN14994, VDI3673** and **NFPA 68**.

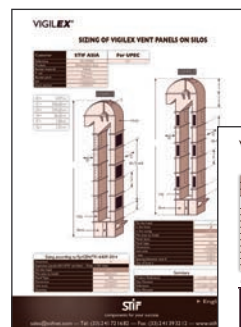

VIGILEX® VENT

SOFTWARE FOR VENT AREA CALCULATION

According to the standards **EN 14491**, **EN 14994** and **VDI3673**, the vigilex vent software enables you to define the vent area needed to protect your application by yourself.

After your initial request to access on our site, you receive a code confirmation within 24 hours to have access to our vent area calculation software.

This software provide diferents vessels and machinery:

Silos, Filters, Elevators & Building.

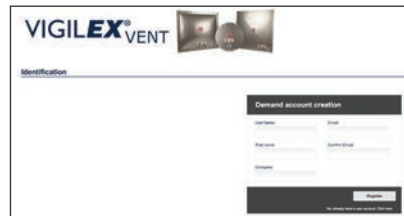

DRAWINGS

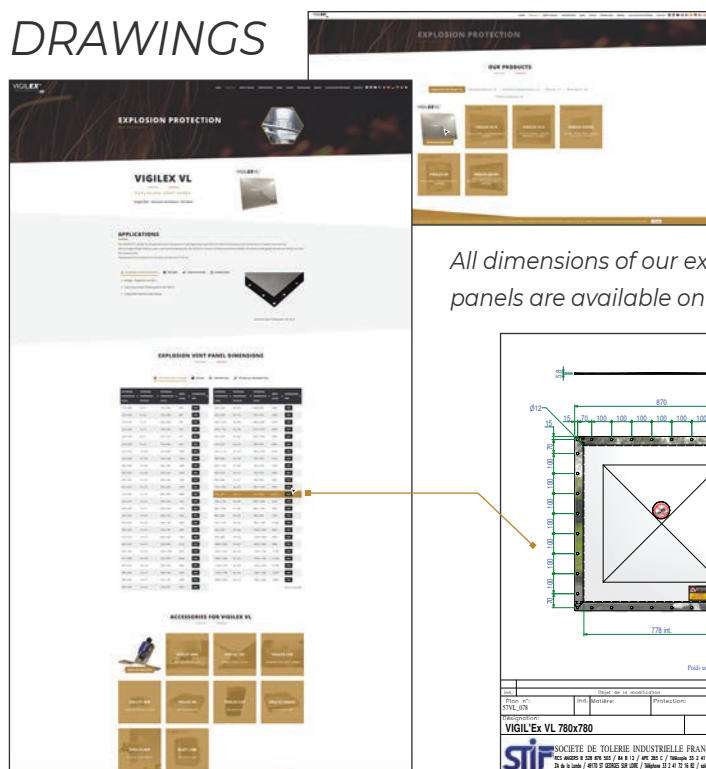

All dimensions of our explosion panels are available on our website

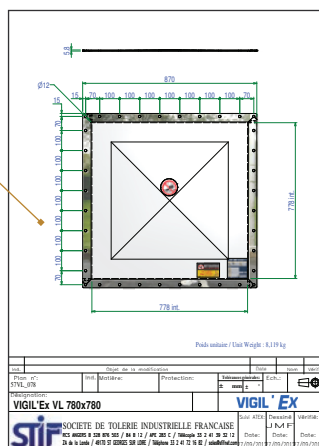

CERTIFICATES



VIDEOS OF TESTS

Test for vent panel and flameless



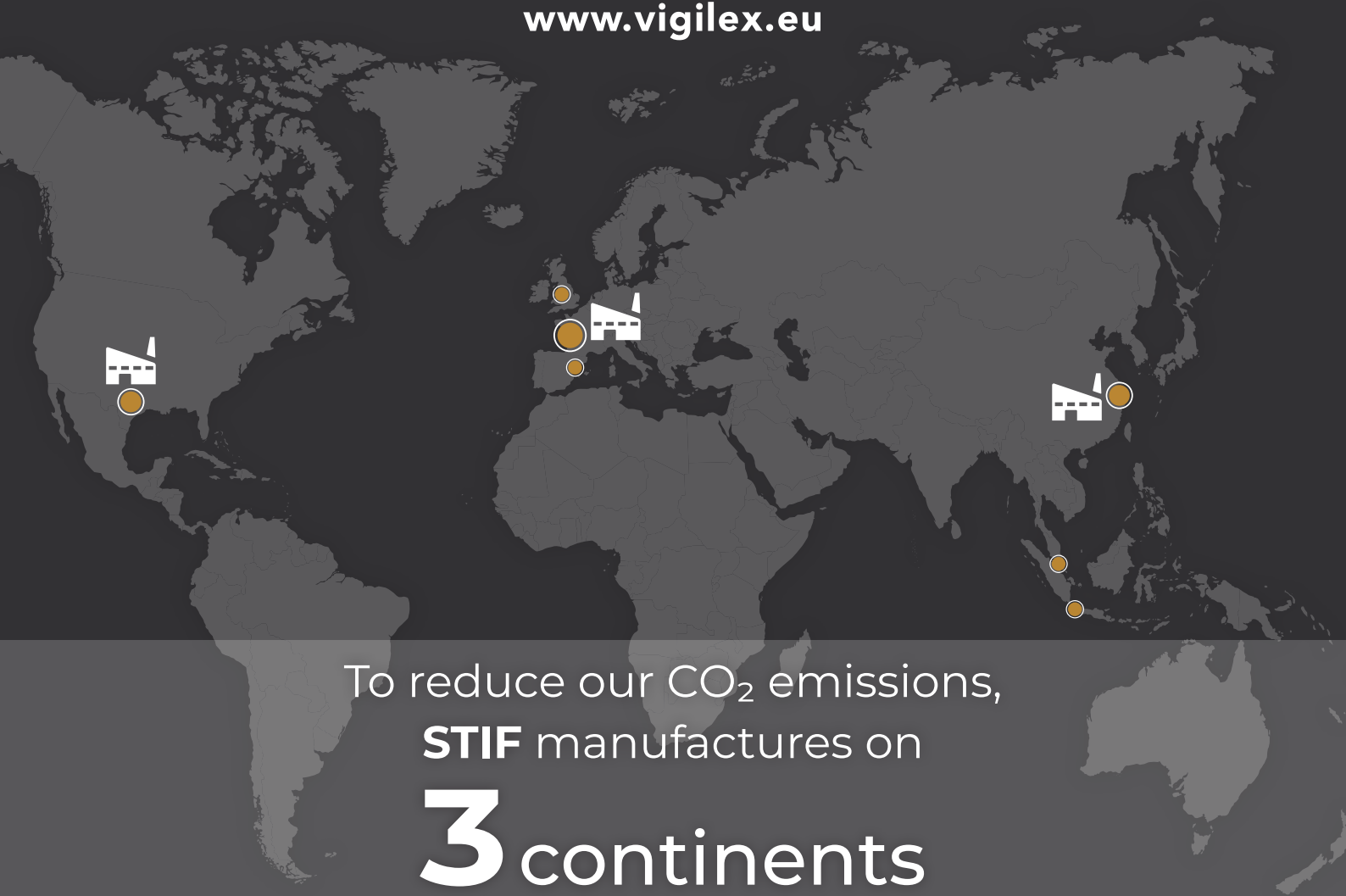

To reduce our CO₂ emissions,
STIF manufactures on
3 continents



EUROPE

**STIF (Head Office)
Factory**

Z.A. de la Lande
49170 Saint-Georges-sur-Loire
FRANCE
Tél.: +33 2 41 72 16 80
E mail: sales@stifnet.com
Web: www.stifnet.com

**STIF IBERICA
Sales Office**

Carrer Doctor Zamenhof, 22. Local
08800 Vilanova i La Geltrú
BARCELONA - ESPAÑA
Tel.: +34 938 950 262
E mail: ventas@stifiberica.es
Web: www.stifnet.com

**STIF DEVELOPMENT LTD
Sales Office**

10 Trinity House
Trinity Gardens
Frodsham
WA67GB - UNITED KINGDOM
E mail: info@macclancyandsons.co.uk
Web: www.vigilexuk.com



ASIA

**STIF (SUZHOU)
Factory**

Unit 7, N° 2318
East Taihu Lake Road
Wuzhong District, Suzhou City
Jiangsu Province, CHINA
Ph.: +86 512 6656 8968
E mail: sales@stif.cn
Web: www.stif.cn

**STIF ASIA
Sales Office**

2 Jurong East St 21
04-28K IMM Building
SINGAPORE 609601
Ph.: +65 6563-2098
E mail: sales@stif.com.sg
Web: www.stifnet.com

**PT. STIF INDONESIA
Sales Office**

Jl. Ratna no. 1A
BEKASI - 17412
INDONESIA
Ph.: +62 21 8499 6745
E mail: indo@stif.com.sg
Web: www.stifnet.com

AMERICA

**STIF USA LLC
Factory**

6729 Guada Coma Dr.
Schertz, TX 78154 USA
Off # 210-664-4200
E mail: sales@stifusa.com
Web: www.stifnet.com



components for your success

